

LokProgrammer

Instruction manual

For software version 2.6.2. and following versions

Article no.: 53450 / 53451

March 2009



Declaration of Conformity	3	7. Edit CVs	10	8.6.17. Behaviour of function buttons	14
WEEE-Declaration	3	8. The „decoder“ register	10	(LokSound 2 mode) (CV 49)	14
1. Important notes – Please read this first	4	8.1. View window „address“	11	8.6.18. Märklin® delta mode (CV 49)	14
2. Installation and start-up of the LokProgrammer	4	8.1.1. Address (CV1, CV17, CV18)	11	8.7. Manual CV entry	14
2.1. System requirements	4	8.1.2. Consist settings (CV 19)	11	8.8. Special options (CV 124)	15
2.2. Connecting the LokProgrammer	4	8.2. Driving characteristics	11	8.9. Identification (CV 7, CV 8)	15
2.3. Installing the software	4	8.2.1. Selecting the number of speed steps (CV 29, CV 49)	11	9. Sounds	15
2.4. Starting the program	4	8.2.2. Reverse mode (CV 29)	11	9.1. Concept of LokSound	15
2.5. Software updates	5	8.2.3. Acceleration and deceleration (CV 3, CV 4)	11	9.2. Basic methodology for working in the „Sound“ register	15
2.6. Firmware updates	5	8.2.4. Supported brake modes (CV 51)	11	9.2.1. Nomenclature	15
3. LokSound basics	5	8.2.5. Trimm (CV 66, CV 95)	11	9.2.2. Importing / Deleting sounds in projects	15
3.1. Sound characteristics of locomotives	5	8.3. Motor	11	9.2.3. Allocate / Delete sounds to (from) sound slots	16
3.1.1. Steam locomotive	5	8.3.1. DC motor PWM frequency (CV 49)	11	9.2.4. Extended functions in the „Sound“	16
3.1.2. Diesel locomotive (diesel-electric)	5	8.3.2. Load compensation (CV 49, CV 53 until CV 56)	11	9.3. Schedule	16
3.1.3. Diesel locomotive (diesel-hydraulic)	6	8.3.3. Speed curves (CV 2, 5, 6, 26, 67-97)	11	9.3.1. Schedule for running (driving) sounds	17
3.1.4. Diesel locomotive with manual transmission	6	8.4. DCC / Analogue	11	9.3.2. Schedule for fan sounds	17
3.1.5. Electric locomotive	6	8.4.1. Zimo® manual function	11	9.3.3. Thresholds in the schedule for running (driving) sounds	18
3.2. User defined sounds	6	8.4.2. Analogue mode (CV29)	11	9.4. Setting the schedule	18
3.3. Automatic / Random sounds	7	8.4.3. Supported analogue modes and settings	11	9.4.1. Soundslots in detail	18
3.4. Digital system / Protocols	7	8.4.4. Analogue mode F1-F8 / Analogue mode FL, F9-F12	11	9.4.2. Sound settings	19
3.4.1. DCC (NMRA)	7	8.5. Sound settings	12	9.5. Random sounds	19
3.4.2. Motorola®	7	8.5.1. Type of sounds (CV57, CV58)	12	9.6. User sounds	20
3.4.3. M4	7	8.5.2. Minimum time between exhaust chuffs (CV 249)	12	9.6.1. General settings	20
3.4.4. Selectrix®	7	8.5.3. Random sounds (CV 61, CV 62)	12	9.6.2. Special options for slots 14, 15 and 16	20
3.5. CVs	7	8.5.4. Speed of driving sound (CV 59, 60)	12	9.7. Alternative sounds	20
3.5.1. Definition and application	7	8.5.5. Brake sound threshold (CV 64)	12	10. Special configurations for M4	21
3.5.2. Advantages / Disadvantages	7	8.5.6. Sound volume	12	10.1. „M4 Settings“ in the „Decoder“	21
3.6. Further information about LokSound decoders	7	8.5.7. Load dependent sound	12	10.2. Driving characteristics	21
3.6.1. General	7	8.5.8. Sound steam shift (CV 250, CV 251, CV 252)	12	10.3. Motor	21
3.6.2. Connecting the speaker	7	8.6. Function mapping	13	10.4. Motorola® settings	21
3.6.3. Suitable sounds	8	8.6.1. Description of the matrix columns	13	10.5. Analogue settings	21
3.6.4. Supported hardware	8	8.6.2. Head lights, back-up lights	13	10.6. Sound settings	21
4. Purpose of the LokProgrammer software	8	8.6.3. Aux 1-4	13	10.7. Function outputs	21
4.1. Overview	8	8.6.4. Acceleration and coasting of diesel locomotives	13	10.8. Special options	21
4.2. Assistant	8	8.6.5. Acceleration / Deceleration	14	10.9. Sound	21
5. Main screen	9	8.6.6. Shunting mode	14	11. Special settings for Loksound micro and XL	21
5.1. Registers	9	8.6.7. Sound on/off	14	11.1. Special settings for Loksound micro	21
5.2. Task bar	9	8.6.8. Shift mode	14	11.2. Special settings for Loksound XL	21
5.3. Tool bar	9	8.6.9. Fan sound	14		
6. Virtual driver's cab	10	8.6.10. Doppler effect	14		
		8.6.11. Volume / Mute	14		
		8.6.12. Dynamic brake	14		
		8.6.13. Sound slots	14		
		8.6.14. Configuration of outputs (lights and AUX-outputs)	14		
		8.6.15. Blinking frequency of strobe effects (CV 112)	14		
		8.6.16. Activate LGB® mode (CV 49)	14		

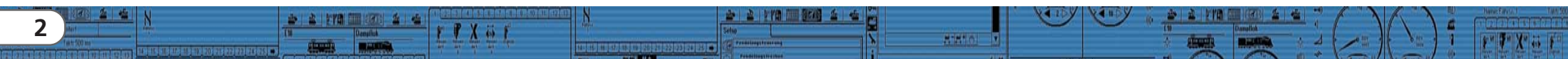

12. Project examples	21
12.1. Available sounds	21
12.2. Project for a steam locomotive	22
12.2.1. Create a new file	22
12.2.2. Settings	22
12.2.3. Import and place sounds	22
12.2.4. Function mapping	23
12.2.5. Set the wheel synchronicity of exhaust chuffs	24
12.2.6. Fine tuning	24
12.3. Diesel-electric locomotive	24
12.3.1. Generate new file	24
12.3.2. Settings	24
12.3.3. How to import and set sounds	25
12.3.4. Function mapping	25
12.3.5. Fine tuning	25
12.4. Diesel-hydraulic / Diesel-mechanical	26
12.4.1. Generate new file	26
12.4.2. Settings	26
12.4.3. How to import and set sounds	26
12.4.4. Function mapping	26
12.4.5. Fine tuning	26
12.5. Electric locomotive	26
12.5.1. Generate new file	26
12.5.2. Settings	26
12.5.3. How to import and set sounds	26
12.5.4. Function mapping	27
12.5.5. Fine tuning	27
13. APPENDIX	28
13.1. Miscellaneous	28
13.1.1. Activating the Doppler effect during operation	28
13.1.2. Hardware of LokSound (cables, colours)	28
13.1.3. Problems when reading the decoder	28
13.1.4. Memory types 8Mbits and 16Mbits	28
13.2. Customer service – Assistance and support	28
13.3. CV overview chart	29
14. Licence Agreement	34
15. Warranty Certificate	36

Declaration of Conformity

We, ESU electronic solutions ulm GmbH & Co KG, Industriestraße 5, D-89081 Ulm, declare herewith in sole responsibility compliance of the product "LokProgrammer" to which this declaration is related to, with the following standards:

EN 71 1-3 : 1988 / 6 : 1994 – EN 50088 : 1996 – EN 55014, part 1 + part 2 : 1993

EN 61000-3-2 : 1995 – EN 60742 : 1995 – EN 61558-2-7 : 1998

The „LokProgrammer“ bears the CE-mark according to the guidelines as per

88 / 378 / EWG – 89 / 336 / EWG – 73 / 23 / EWG

WEEE-Declaration

Disposal of old electrical and electronic devices (applicable in the European Union and other European countries with separate collection system). This mark on the product, the packaging or the relevant documentation indicates, that this product may not be treated as ordinary household garbage. Instead this product has to be delivered to a suitable disposal point for recycling of electrical or electronic equipment. By disposing of this product in the appropriate manner you help to avoid negative impact on the environment and health that could be caused by inappropriate disposal. Recycling of materials contributes to conserve our natural environment.



For more information on recycling this product please contact your local administration, the rubbish disposal service or the shop where you have purchased this product.

Batteries do not belong into household trash!

Please do not dispose of discharged batteries in your household trash: take them to a collection point at your local town hall or dealer. Thus you assure an environmentally friendly way of disposal.

Copyright 1998 - 2009 by ESU electronic solutions ulm GmbH & Co KG. Irrtum, Änderungen die dem technischen Fortschritt dienen, Liefermöglichkeiten und alle sonstigen Rechte vorbehalten. Elektrische und mechanische Maßangaben sowie Abbildungen ohne Gewähr. Jede Haftung für Schäden und Folgeschäden durch nicht bestimmungsgemäßen Gebrauch, Nichtbeachtung dieser Anleitung, eigenmächtige Umbauten u. ä. ist ausgeschlossen. Nicht geeignet für Kinder unter 14 Jahren. Bei unsachgemäßem Gebrauch besteht Verletzungsgefahr.

Märklin® ist ein eingetragenes Warenzeichen der Firma Gebr. Märklin® und Cie. GmbH, Göppingen. RailCom® ist ein eingetragenes Warenzeichen der Firma Lenz Elektronik GmbH, Giessen. Alle anderen Warenzeichen sind Eigentum ihrer jeweiligen Rechteinhaber.

ESU electronic solutions ulm GmbH & Co. KG entwickelt entsprechend seiner Politik die Produkte ständig weiter. ESU behält sich deshalb das Recht vor, ohne vorherige Ankündigung an jedem der in der Dokumentation beschriebenen Produkte Änderungen und Verbesserungen vorzunehmen.

Vervielfältigungen und Reproduktionen dieser Dokumentation in jeglicher Form bedürfen der vorherigen schriftlichen Genehmigung durch ESU.



Installation and start of the LokProgrammer

1. Important notes – Please read this first

Thank you for purchasing the LokProgrammer set 53450/53451. With the LokProgrammer you can program ESU LokPilot- and LokSound decoders.

The LokProgrammer 53450 consists of two elements: An interface module that serves as the physical connection between the PC and the locomotive, and the software that can be run on any PC using MS Windows. The set 53451 has an additional USB adapter but is otherwise the same as 53450.

Never was it easier to program a digital decoder than with LokProgrammer. Thanks to the graphic interface of MS Windows you can achieve the optimal adaptation of LokSound decoders even if you have very little or no experience in programming digital decoders. This combination allows you to easily manipulate and adjust the many features and properties of LokSound decoders with your PC.

LokProgrammer also allows you to modify all sound fragments and sound effects stored on the decoder as often as you desire.

ESU provides over 100 different sound files on the ESU web site at www.esu.eu. You will certainly find the right sound for your locomotive.



Please also take note of the license agreement regarding downloading and using the sound files contained in the appendix.

This manual describes in detail how to modify sounds and which methods to use to achieve the desired results.

We wish you lots of fun in the world of LokSound.

ESU electronic solutions ulm GmbH & Co KG, March 2009

2. Installation and start-up of the LokProgrammer

Please note the remarks regarding installation to assure that your LokProgrammer software keeps working to your full satisfaction!



2.1. System requirements

In order to use this software you need a commercially available PC with the following requirements:

- Operating system: Microsoft Windows 98, 2000 or XP, also Vista as from version 2.6.3; but not Windows NT
- CD-ROM drive
- One serial port or an USB interface on your PC
- Audio card
- 10MB minimum available memory on your hard disc

For the utilization of the sound files with this software an Audio Card must be installed. All cards with a Windows driver are suitable.



2.2. Connecting the LokProgrammer

The LokProgrammer has to be connected as shown in Figure 1: Use the serial cable respectively the USB-adapter cable provided to connect the LokProgrammer to any available COM port (or USB-port) of your PC. Which port you select is immaterial.

Please make sure that the programming track is completely isolated from the rest of the layout to avoid possible damage of your LokProgrammer hardware!

Also make sure that there are no electrical connections between the individual wires.

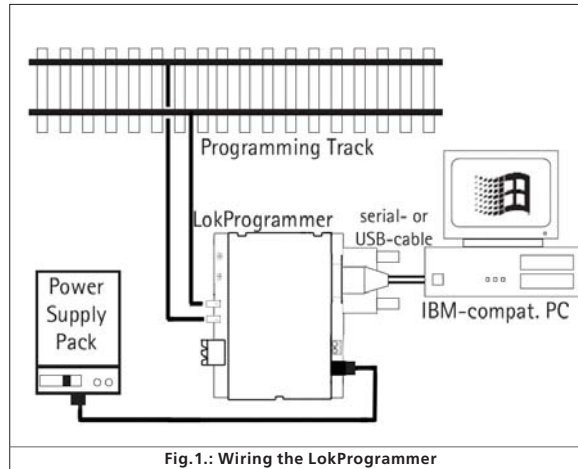

Fig. 1.: Wiring the LokProgrammer

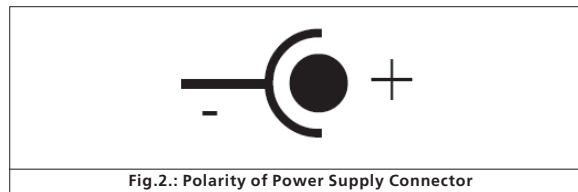

Fig. 2.: Polarity of Power Supply Connector



Never connect both terminals at the same time. This could destroy the LokProgrammer!



After connecting the power supply the green LED on the LokProgrammer should light up.

The terminals „Track Out“ on the LokProgrammer are to be wired to the programming track. Polarity is irrelevant.

Make sure that the programming track is fully isolated from the layout!

The two LEDs on the LokProgrammer indicate the following:

Green LED:

- Is lit continuously when supply voltage is available.
- Blinks when the LokProgrammer receives data from the PC.

Yellow LED:

- Blinks quickly when voltage is applied to the programming track and data is transferred.
- Blinks slowly if the LokProgrammer detects a high current and is disconnecting the programming track.

2.3. Installing the software

Make sure that the LokProgrammer is connected as described above and is ready for use.

As soon as you insert the CD-ROM into the drive the installation program is starting automatically.

Should this not be the case select the CD-ROM drive in „Desk Top“ or in the „Windows Explorer“ and click onto „Set up“.

Alternatively you may click on the START button in the tool bar and select „Run“. Then type „x:\setup.exe“ and „OK“. Of course you must enter the name of the CD-ROM drive instead of the „x“ (usually „D“):

After a short while the program should start. Follow the instructions on the monitor and wait until the program is installed on the hard disk.

2.4. Starting the program

The installation program creates an entry in the start menu. Select „LokProgrammer vX“ in the Start menu under „Programs“; „X“ stands for the version number of the software. Select „LokProgrammer“. Then the program will start.

LokSound Basics

2.5. Software updates

ESU offers the latest version of the LokProgrammer software on the web page www.esu.eu. You will find it in the „Downloads“ menu under „Software“. Click onto the Download-symbol at the end of the line. A window opens. Click „Run“. Now the program will guide you through the installation procedure.



Fig.3.: Start Window for Internet Update

There is also an option for an automatic update provided the software is already installed on your computer:

- Go into the Start Menu and select Program „LokProgrammer vX“, (the X stands for the version number of your software).
- Click onto „Internet Update“. A window as per Fig. 3 opens.
- Click onto „Next“. The note „Downloading required Files. Please be patient“ appears. While this window is shown the files required for the update will be installed. Subsequently you can start the LokProgrammer software from the installation window.

Please note that software version 2.6.6. only runs and opens appropriate data (meant for version 2.6.6. and all following updates). The software doesn't run former or previous versions (before version 2.6.6).



2.6. Firmware updates

The firmware is the operating system of the LokPilot- or LokSound decoders.

Please note: Certain new software options can only be activated with LokSound decoders with the latest firmware-update. You will find the latest firmware-updates on our website at www.esu.eu under „Download“ and „Software“.

Update procedure:

- Connect the desired decoder to the LokProgrammer and start the update.
- Select „Run“ in the pop-up window.
- Follow the instructions for installation.
- First the firmware-update will be installed on your PC, then the update will be downloaded onto your decoder.



Privacy Protection:

ESU guarantees that no information will be downloaded from your PC to the ESU website. Data transmission is strictly limited to sending data from the ESU home page to your PC. Your personal data are protected at any time.

3. LokSound basics

In the following chapter it is explained how the LokSound decoder reproduces prototypical sounds, what options are available with digital command control for model trains and which protocols of digital systems are currently available in the market. Should you already have experience with digital systems and also be familiar with locomotive sounds you may skip this chapter and continue reading on page 16.

3.1. Sound characteristics of locomotives

With LokProgrammer and LokSound decoders you can reproduce sounds of steam locomotives, diesel-hydraulic and diesel-electric locomotives, electric locos or locos with manual transmission (e.g.: rail car). Of course the sound sequences are subject to the type of locomotive.

3.1.1. Steam locomotive



The dominant sounds of a steam locomotive are the hissing of the boiler and the exhaust chuffs when the locomotive is running. The chuffs are synchronized to the revolutions of the drivers and therefore accelerate or slow down whenever the locomotive runs faster or slower. We differentiate between locomotives with 2 or 4 cylinders and others with 3 cylinders. A steam locomotive with 3 cylinders generates either 3 or 6 exhaust chuffs per revolution of the drivers while a 2- or 4-cylinder locomotive generates 4 exhaust chuffs per revolution.

The exhaust chuffs appear to be louder and harder during acceleration compared to normal running at constant speed. Whenever the valves are closed the only audible noise is the clank of the driving rods.

When the locomotive starts moving, the cylinder valves are open in order to push out any condensed steam and thus to avoid breakage of the driving rods.

This behaviour can be simulated with LokSound decoders and with the aid of the LokProgrammer. The individual stages are

divided into separate Driving notches. The different sounds of the respective stages consist of individual recordings of the exhaust chuffs (also refer to Fig. 4 and chapter 9.4.1 for detailed explanations).

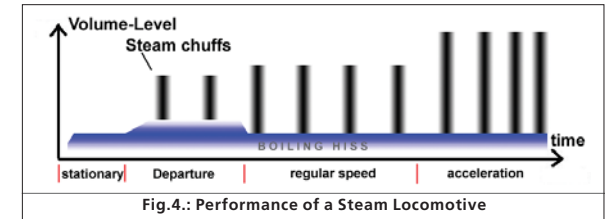

Fig.4.: Performance of a Steam Locomotive

3.1.2. Diesel locomotive (diesel-electric)



Diesel-electric locomotives are in principle electric locomotives with electrical generators that are powered by diesel engines. The diesel locomotive is generally driven at constant Driving notches subject to the speed of the locomotive. Therefore the noise generated changes (driving) step by (driving) step. The quiet electric motor can hardly be heard over the noise of the diesel powered plant. Most diesel-electric locomotives have 4 to 8 throttle notches. The LokProgrammer can handle up to 10 throttle notches plus one each for acceleration and idle respectively coasting (for more info please refer to chapter 12.3).

Examples of diesel-electric locomotives are the DB class 232 („Ludmilla“), most American diesel locomotives by GE or ALCO or the MZ-locomotives by the Danish State Railways.

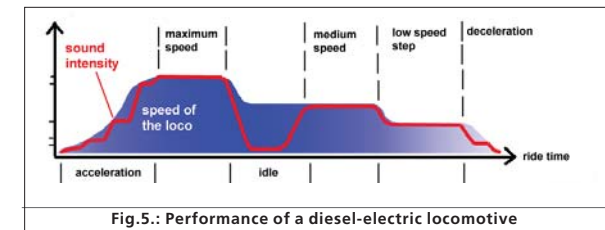

Fig.5.: Performance of a diesel-electric locomotive

3.1.3. Diesel locomotive (diesel-hydraulic)



The main item of equipment of a diesel-hydraulic locomotive is the torque-converter that uses fluids for power transmission. This energy flow is literally „fluent.“

That is the reason why diesel-hydraulic locomotives howl audibly once the throttle is opened and before the locomotive is actually moving. Since the revs of the motor sound depend on the speed, the noises generated during driving change without audible thresholds. Simply put, the sound is directly proportional to the speed.

Locomotives with LokSound decoders behave the same way; first the diesel engine revs up and once the revs are high enough the locomotive starts moving. The pitch of the sound can be adjusted subject to the speed. This is only possible in a combined unit (decoder plus sound module in one piece – for further info also refer to chapter 8.5.4).

Examples for diesel-hydraulic locomotives are the DB class V200 (class 220) and the Regio-Shuttle or the DMU41 by the SNCB/NMBS.

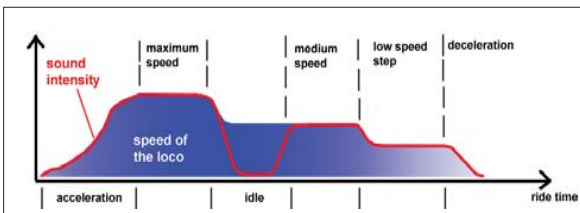

Fig.6.: Performance of a Diesel-hydraulic Locomotive

3.1.4. Diesel locomotive with manual transmission (manual gear gear box)



Diesel locomotives with manual transmission employ pinion gear for transmitting the power from the motor to the wheels similar to automobiles. The clutch is pressed during shifting from one gear to the next and thus the power transmission is interrupted for a short moment. The shifting of gears can clearly be heard in many a diesel locomotive with manual transmission. With the LokProgrammer software you can either store the original sound of gear shifting or you may choose the option „gear shift“ (User-Sound Slot 14) as described in chapter 9.6.2:

Examples of diesel locomotives with manual transmission are the German rail cars VT95 or some shunting locomotives, since manual transmissions are only practical in vehicles of relatively low weight and with low maximum speeds.

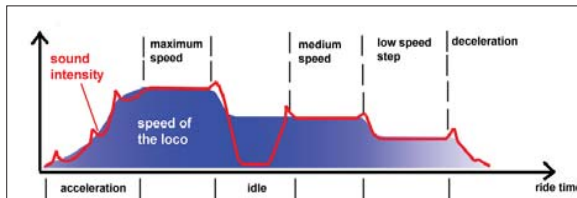

Fig.7.: Performance of a Diesel Locomotive with Manual Transmission

3.1.5. Electric locomotive



There are different sound types for electric locomotives. On the one hand the hum of the electric traction motor(s) is audible; it changes its pitch with the speed similar to diesel-hydraulic locomotives.

Other electric locomotives generate very dominant fan sounds. In some electric locomotives the sound of the fan is constant and therefore the sound does not change during driving.

By and large electric locomotives are not as noisy as other locomotive types and therefore they are ideal for applying User Sounds such as the whistle, horn, compressor, etc. (for more info please refer to chapter 9.5 and 9.6).

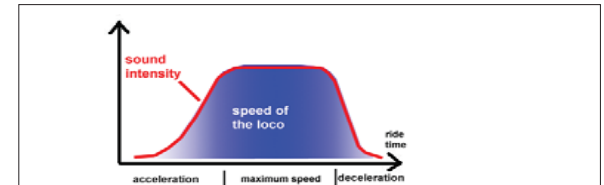

Fig.8.: Performance of an Electric Locomotive

3.2. User defined sounds



User-defined sounds („User-Sounds“) could be horns and whistles, coupler clank, sanding, etc. These sounds can be triggered by pressing a function button on your throttle once you have programmed them onto the decoder. Currently LokSound decoders support up to 16 functions such as head lights, smoke generator, etc. The latest versions of digital command stations such as the ESU ECoS can fully utilize this range.

3.3. Automatic / Random sounds

Random Sounds are triggered automatically and irregularly and can be used for safety valves, fans, compressors, etc.

With the LokProgrammer you can select the time between Random Sounds (details in chapter 8.5.3).

Other possibilities for triggering sounds automatically such as squealing brakes are contained in Function Mapping and the sound schedule (see chapter 9). Such sounds will be triggered at specific times.

3.4. Digital system / Protocols

In this chapter we list all digital protocols for running model trains and setting signals and turnouts that are supported by the LokProgrammer.

3.4.1. DCC (NMRA)

DCC stands for „Digital Command Control“ and was formulated as standard by the NMRA (National Model Railroad Association).

In the early stages operation was limited to 14 speed steps and 80 addresses; today up to 10,000 addresses and 128 speed steps are available.

DCC is downward compatible in terms of control and decoders, e.g. older decoders can be controlled with up-to-date command stations / throttles and with certain limitations new decoders can be operated and programmed with older control devices.

3.4.2. Motorola®

The Motorola®-protocol goes back to 1984 is one of the oldest digital systems for model trains. Due to its age the operational options are limited.

The Motorola®-protocol can only handle 80 locomotive addresses with 14 speed steps and besides the headlight function only four additional function outputs can be controlled (functions 5-8 can be selected with the second Motorola®-address).

Since the Motorola®-protocol is still used in many digital systems ESU decoders are designed to work with this protocol as well.

3.4.3. M4

Since 2004 the MFX®-system is on the market. Theoretically this could run more than 16,000 model locomotives simultaneously with 128 speed steps.

The LokProgrammer software deals with certain settings somewhat differently to DCC.

For instance, instead of locomotive addresses the name of the locomotive has to be entered (e.g.: „class 01“ or „ICE“). The allocation of certain parameters to the CVs is also different to DCC.



Do not use the DCC-CVs mentioned from chapter 3.5 onwards for M4!



What does M4 mean?

At some points in this manual you will notice the term „M4“ for the first time and rightly wonder what this might mean.

This question can be answered quite simply: from 2009 forward, M4 is the name of a data protocol that was chosen by ESU to be implemented in their decoders. Decoders with the M4 protocol are one hundred percent compatible with command stations using mfx®. At such stations (e.g. Märklin® Central Station®) they will be recognized automatically and all playing functions are available just like when using mfx®. On the other hand, our ESU command stations using M4 will recognize all (Märklin® and ESU) mfx® decoders without any restrictions and will still work without any problems. As the (mutual) inventor of mfx® we can assure you of this.

In short: the technique stays the same, only the name has been changed.

3.4.4. Selectrix®

Selectrix® is another digital system. In contradiction to DCC the locomotive addresses are not transmitted individually but in groups. Thus it is limited to the driving sounds and Random Sounds but it is not possible to trigger any user defined sounds (e.g.: a whistle or bell). Selectrix® is almost exclusively used for N scale and Z scale; therefore it is also supported by the ESU LokSound micro decoder.



It is important not to confuse these systems when programming any sounds. For instance it is not possible to store any M4-project files on a DCC-decoder let alone to replay them.

3.5. CVs

3.5.1. Definition and application

CV stands for „Configuration Variable“. CVs can have values in bits or bytes. The CVs with bytes can have a range from 0 to 255 while the CVs programmed in bits function as on / off-switches.

Examples:

CV 63 (sound volume) is a CV that can be programmed byte-wise with a maximum value of 64. The value 0 means no sound while 64 stands for maximum sound volume.

In CV 49, bit 0 is a „switch“ for activating load compensation (as per 8.3.2). Is this bit set to 0, load compensation is deactivated, is it set to 1, and then load compensation is active.

The NMRA (National Model Railroad Association) has allocated certain CVs to certain functions. For instance CV 1 is always used for the address, CV 5 for the maximum speed.

3.5.2. Advantages / Disadvantages

Digital decoders can be programmed without the need of comprehensive programming knowledge or equipment. Many digital command stations also offer internal programming menus.



Furthermore the programming with bits and bytes requires little memory space. Programming solely with CVs is not easy to remember and depending on the type of command station it can be quite cumbersome.



Furthermore CVs have only limited effect on sounds in LokSound decoders (e.g.: sound volume). The actual sounds cannot be adjusted with CVs but depend on the actual sound recording. In the LokProgrammer software CVs are shown in registers or as slide controls and can therefore easily be set to the desired values.

3.6. Further information about LokSound decoders

3.6.1. General

At the core of a LokSound decoder is a powerful processor. It is supported by an audio amplifier and a sound memory that can store up to 130 seconds of sound.

The four channel mixer with active filter can replay four different sounds simultaneously: One channel is reserved for the driving noises while the other three can be used for User Sounds (such as bells, whistles, etc.) and Random Sounds (e.g.: automatic safety valves or shovelling coal). All four channels will be mixed to one output in the decoder and transmitted to the speaker.

The memory of the LokSound decoder can be deleted at any time to make room for new sounds. Thus it is no problem whatsoever to modify a steam sound decoder into diesel sound. You can easily do that yourself with the aid of the ESU LokProgrammer whenever you want to!

Please note: this unimpeded change of sounds is limited to decoders sold for installation into locomotives by the user. LokSound decoders that are installed in locomotives by a model train manufacturer may not always offer this option!

A field at the lower edge of the screen shows the available memory space during programming (in seconds and bytes) as well as the total capacity of the particular decoder. Select the „Sound“ register and then one of the sound displays in order to see this (also refer to chapter 9.).



If you wish to save some files but do not have enough memory space on the decoder you may have to delete some sound files from this project. Alternately you can shorten some of the sound fragments with your audio-program.

3.6.2. Connecting the speaker

The speaker is the end piece of the sound equipment. Of course we can only install small speakers into our model locomotives.

Therefore the speaker must meet a very demanding specification. ESU offers a range of speakers of different size and for different decoder types.

Please note that the audio output of the LokSound decoder is designed for 100 Ohm speakers. Speakers with other resistance values may cause overheating of the amplifier in the decoder or simply result in lower sound volume.

If you wish to install two speakers in one model it is best to use two 50 Ohm speakers in series.



Tasks of the LokProgrammer Software

3.6.3. Suitable sounds

ESU offers many different sound files for all sorts of locomotives on the website www.esu.eu. Please take note of the licensing conditions mentioned in the appendix regarding the download of sound files. Of course you can program your own sound projects on your LokSound decoder.

Generally you may use all files in Windows *.wav-format for LokSound decoders. WAV is the standard format for storing sounds of any kind on windows. If the recording is noise, music or speech makes no difference.

The files can originate from the CD-ROM supplied with the LokProgrammer, they could be downloaded from the internet or they could be created by you.

Wave-files can be stored in different levels of sound quality on the hard disc. The better the sound quality, the more memory space is required.

In order to achieve optimal sound quality you should use wave files that match the respective LokSound decoder:

Sampling frequency: (corresponds roughly with double The displayed hearing frequency)	15625 Hz
Resolution (corresponds with volume driving steps):	8 Bit
Number of channels:	1 (Mono)

The program automatically converts the files to the suitable format matching the particular decoder. However, under certain circumstances this could lead to lower sound quality.

Hint:

It would be best to prepare the wave file by adjusting them to the above mentioned sampling frequency, resolution and number of channels matching the corresponding parameters of the decoder.

Firstly, this helps to save memory space while assuring the best possible sound quality. Secondly, one can appraise the sounds best during the preparation phase.

There are a number of programs for generating wave files. The best known ones are Windows-Media Recorder for recording sounds and to save them in digital format as *.wav file on the hard disc. There are also more sophisticated audio editors that offer professional features such as tone control, echo, editing, etc.

It is recommended to record sounds with hard discs or other high fidelity audio recorders in order to achieve a high level of sound quality. Cassette recorders or even worse dictaphones are not suitable.

In this manual we cannot provide comprehensive instructions on how to convert sound to digital files and how to save them on a hard disc. Please observe the manuals that were supplied with your PC or with your audio card.

3.6.4. Supported hardware

The LokProgrammer software as from version 2.5.0 supports only the LokProgrammer 53450 „LokProgrammer V3.0“. Using this software with older versions of the LokProgrammer (e.g.: 50450) is currently not possible.

The number of supported decoders varies subject to the LokProgrammer version.

The versions as from 2.6.1. support the following ESU-decoders:

- LokSound V3.5 with 8 and 16 MBit memory for 0 scale and H0 scale (DCC and Motorola®)
- LokSound micro for TT and N scale (DCC, Motorola® and Selectrix®)
- LokSoundXL V3.5 for G and I gauge (DCC and Motorola®)
- LokSound M4 for 0 and H0 scale for the users of Märklin® systems.

In addition the following (partly older product versions) are supported:

LokSound V3.0, LokSoundXL V3.0, LokSound2, LokSoundXL V2.0, LokPilot, LokPilotDCC, LokPilotXL, LokPilotXL DCC.

The LokProgrammer software is subject to continuous development. In order to assure that you always work with the latest software version you should regularly call up the internet update facility. Whenever a new version with extended functionality and bug fixing is available it will be placed in the download section on our website.

The appearance on the screen may change subject to the features of a specific decoder. Therefore in certain cases only some of the features described here will be active or even more options may be available. Please always refer to the manual supplied with the decoder.



4. Purpose of the LokProgrammer software

In the following chapters the program functions of the LokProgrammer will be described. First the general functions and then the more special possibilities of adjusting ESU decoders (LokPilot and LokSound).

The appropriate CV in the DCC protocol for each option will be named as well as which setting is supported by which ESU decoder. LP stands for LokPilot, LS for LokSound.

Please bear in mind that you can only fully utilize the potential features of a decoder with the latest firmware.

4.1. Overview

- **Setting / changing of all parameters of ESU decoders:** all options can be set comfortably on the PC. Of course it is still possible to manually adjust any CV via digital command stations such as the ESU ECoS-command station.

- **Modification of sound files, that are stored on an ESU LokSound module:** it is possible to change all sound files on the LokSound module at any time, e.g. also at a later stage. Thus you can compose your own sounds using anything as source that can be saved on your PC: locomotive sounds, music, speech, etc. There are no limits to what you can do.

It is for instance easily possible to change the sounds from a steam locomotive to a diesel or electric locomotive - or vice versa.

- **Test new ESU sounds:** With the aid of the virtual cab (see chapter 6) you can test decoders on the programming track.

4. 2. Assistant

As soon as the software is started the assistant window pops up on the monitor. This enables you to call up the most important functions of the program. Subject to which function you select the appropriate window appears immediately. With the help of the assistant you can deal with important tasks easily and quickly.

The assistant helps you to carry out the following tasks:

- To read out decoder data for comfortable evaluation and modification.
- To completely modify the sound files of a decoder in order to easily change a steam sound decoder into one for a diesel locomotive.
- To generate a completely new project
- To open an already saved project.

In order to do this, select the desired option and follow the instructions in the small window

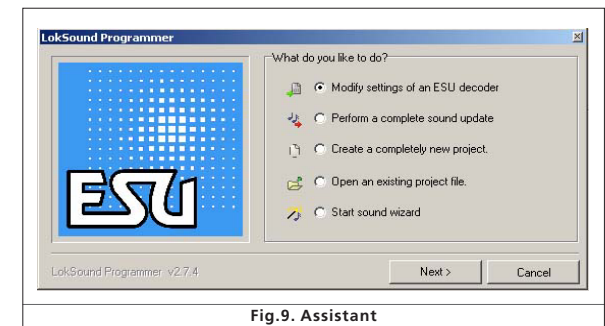

Fig.9. Assistant

5. Main screen

5.1. Registers

According to the different tasks of the program it is divided into different registers and menus. Figure 10 shows the main screen of the LokProgrammer software and its main components:

- **Virtual Cab:** Here you can test decoders in an easy manner
- **Modifying CV's:** individual adjustment of CVs provided the decoder supports DCC (NMRA).
- **Decoder:** for comfortable programming of ESU decoders with a graphic display
- **Sound:** this serves for modifying sounds or to generate new sound compositions for LokSound decoders.

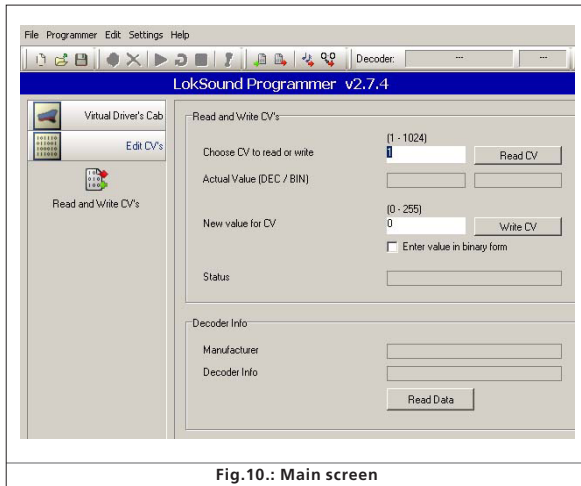

Fig.10.: Main screen

5.2. Task bar

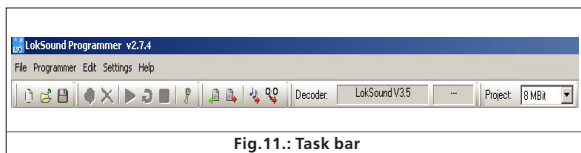

Fig.11.: Task bar

- **File:** in this menu you can do the following with projects:
Generate a new project,
load resp. „open“ a new project, save a project
Please note that all files of the LokProgrammer software version 2.6.6. can only be opened and changed when software version 2.6.6. is used!



You can also call up the internet update facility (refer to 2.5) and close the LokProgrammer software.

During „Saving“ all data, settings and sound files will be written into the project file. Project files are saved with the ending „.esu“.

- **Programmer:** here you can read and write decoder data and read sound files and allocation of addresses. Extended decoder data such as type of decoder and version number of the firmware can also be read here.



Fig.12.: Menu „Programmer“

- **Editing:** in this menu you can enter additional info such as the name of the locomotive or a photo and description of the locomotive. It is also possible to convert LokSound 2 project files into the current format of the LokProgrammer. After this procedure you may have to check the CV values since not all CVs can be transferred.
- **Settings:** here you can determine the project directory and the programming language (German or English). Please note that the new language only operates after restarting the program.
- **Help:** here you can open this manual and obtain other information on this software

5.3. Tool bar



„Add Sound File“. This button is only active when a sound file was selected in the window „Folder“ or at the „Sound“ register.



„Delete Sound File“. This button is only active when a sound file was selected in the window „Project Sound“ or at the „Sound“ register.



„Play Sound File“ for testing purposes. This button is active when a sound file was selected.



„Play Sound File continuously“. This button is active when a sound file was selected. This type of replay is useful for sound loops (driving noises).



„Stop Playing Sound Loop“. This button is active when a sound file was selected.

It is possible to first listen to sounds on your PC prior to adding them to a project. Mark the file you want to listen to in the window „Folder“ (in the window „Sound“ / „Schedule“ in the lower half of the left column). Then click onto

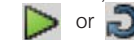

To finish click onto .In this manner you can also listen to sounds that are already contained in the list „Project Sounds“.



„Read Decoder Data“: Prior to changing any data on the decoder it is advisable to read out all decoder data. Place the locomotive on the programming track and make sure the programming track is correctly connected.

Then click onto „Read CVs of the Decoder“ in the task bar at the top of the screen. Alternately you can select the command „Read out Decoder Data ...“ in the menu „Programmer“. The program starts to read the data immediately. Please be patient, this process may take one or two minutes.

The status is displayed in the progress bar.

Should the program not be able to read the data please refer to chapter 13.1.



„Write Decoder Data“: The CVs contained in the project file will be written onto the decoder connected to the LokProgrammer. Click „Continue“ in the window that opens first in order to write the CVs.



All data on the decoder will be replaced by the new data.

Virtual Driver's Cab



„Write Sound Files“: This button enables you to write the sound files contained in the project file onto the decoder connected to the LokProgrammer. Click „Continue“ in the window that opens first in order to write the sound files. Depending on the size of the file and the size of the memory this may take up to 10 minutes.



Please bear in mind, that you have to write the CVs once again, if you have made any changes.



„Write Address Allocations“. Any data contained in the project file regarding the allocation (e.g.: sound slots to function buttons) will be written onto the decoder.

The following fields next to the tool bar are of purely informative character:

LokSoundV3.5

This field shows the decoder type connected to the LokProgrammer. In this example it is a LokSound decoder version 3.5. Of course you can work with any LokSound decoders (as from LokSound 2 upwards), as well as LokPilot-types in DCC (NMRA), Motorola®, M4 and Selectrix ®.

8 MBit

This field shows the size of the sound memory of the decoder. Depending on the type this could be 1Mbit, 2Mbit, 4 Mbit (LokSound 2), 8Mbit or 16Mbit (LokSound 3.5).

6. Virtual driver's cab

With the aid of the virtual cab you can test decoders. You can run the locomotive and trigger all functions. Therefore you can test run your locomotive on the programming track with the LokProgrammer.

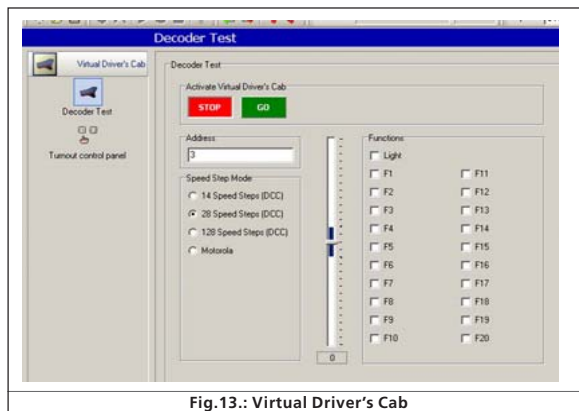

Fig.13.: Virtual Driver's Cab

There are some limitations, though: the LokProgrammer limits the permitted current to about 400 mA. Should the motor of the locomotive draw a higher current than the over current protection will be triggered and the power to the programming track will be shut off. This is indicated by the blinking yellow LED on the LokProgrammer. In this case deactivate the virtual cab and then turn it on again.

All other functions in this register are self explanatory: You can enter the address and the number of speed steps. Please make sure that the speed steps matches the ones set on the LokProgrammer.

The LokProgrammer can run locomotives in DCC format, as from version 2.5 also in the Motorola® format. Due to the hardware the LokProgrammer cannot handle M4. Test your M4 projects in the Motorola® format.



Please check that your programming track is fully isolated from the mainline of your layout prior to turning on the virtual cab. Should there be any electrical bridge it could damage the LokProgrammer (also refer to 2.2.)!

Activate the locomotive for the test run by clicking the field „Activate Cab“.

Control the speed of the locomotive with the slide throttle. Clicking into the appropriate fields turns functions on and off. Up to function F12 you may also press the numbers on your computer keyboard.



Please bear in mind that running a locomotive with the LokProgrammer cannot and should not substitute a command station: due to the limited power of the power pack you will not be able to run more than one locomotive at any one time. The virtual cab simply gives you the opportunity to quickly test run your locomotive.

7. Edit CVs

In the register „Edit CVs“ you can read or write individual CVs. Select the register „Read / Write CVs“.

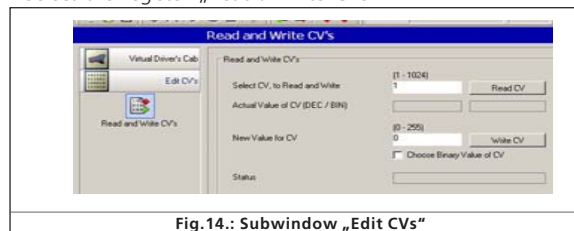

Fig.14.: Subwindow „Edit CVs“

Read a CV:

- Enter the number of the CV you want to read in the upper data entry field.
- Press the button „Read CVs“.
- The result will be shown in binary and decimal format.

Write a CV:

- Enter the number of the CV you want to write in the field at the top.
- Write the new value of the CV in the lower data entry field.
- Click onto the button „Write CVs“.
- The CV will be overwritten with the new value.

You can also read out the manufacturer's code. Simply click onto „Read Data“.



Please bear in mind that any changes made here are not automatically displayed under „Decoder“. You must first read out the decoder data (also refer to chapter 5.3).

You will find a comprehensive list of CVs in 13.1.

8. The „decoder“ register

All settings regarding the motor control part of the decoder are handled in the „Decoder“ register. Please note that this register is initially empty when you start the program. Info will only be displayed in this field after you have generated a new project, opened an existing project or read out a decoder. Projects are an image of all data stored on a decoder.

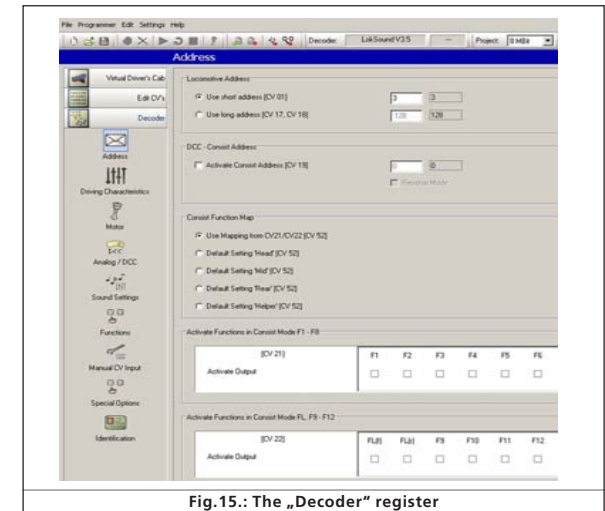

Fig.15.: The „Decoder“ register

The buttons that let you go to the different options are on the left of the screen. Besides movement and sound behaviour you can adjust specific settings such as brake mode, address, etc. On the following pages we will explain the parameters and options.

Subwindow „Decoder“

8.1. View window „address“

8.1.1. Address (CV 1, CV 17, CV 18)

All modifications of the address are done in the window „Address“. Subject to the decoder type so called short (two digits, CV1) or long addresses (four digits, CV17 and CV18) can be used.

Please note that any settings in these CVs are only effective for operation with NMRA-DCC compliant command stations.

When operating decoders with the Märklin® / Motorola®-protocol a separate address, namely the Märklin®-address is valid.

You may enter a second address for M4-decoders in Motorola® mode in order to activate F5 to F8. Normally this would be the address of the decoder plus 1.

8.1.2. Consist settings (CV 19)

The DCC consist address is useful for multiple traction. It is also possible to activate function outputs for consists as well as function buttons for consist mode.

In some cases it is desirable to set certain functions in consist mode in such a way that the function is actually triggered by pressing one button in both (or all) locomotives (e.g.: lights).

Click onto the appropriate button of the function that should be activated in consist mode.

8.2. Driving characteristics

8.2.1. Selecting the number of speed steps (CV 29, CV 49)

Here you can adjust more settings for running your locomotive. In DCC mode you have to first set the number of speed steps to 14, 28 or 128 or alternately to automatic detection of speed steps.

8.2.2. Reverse mode (CV 29)

A tick at „Reverse mode“ changes the direction of travel and the directional characteristics of the headlights. This is useful in case the wiring has been done incorrectly (swapping of track leads or motor leads).

8.2.3. Acceleration and deceleration (CV 3, CV 4)

This option allows you to set the acceleration time (CV3) respectively the braking time (CV4). The time is calculated by multiplying the CV-value with 0.869 seconds.

The acceleration time is the time the locomotive takes from stop to maximum speed. Of course the acceleration time from stop to mid speed is accordingly shorter.

The same is valid for the braking time. This is the time from maximum speed until the locomotive stops.

8.2.4. Supported brake modes (CV 51)

Here the brake modes can be selected. The LokProgrammer supports the Märklin®-, Zimo- and Lenz-brake modes.

8.2.5. Trim (CV 66, CV 95)

The trim function allows you to set the maximum speed separately for forward and reverse movement. The factor that is used to multiply the motor voltage, results from dividing the CV-value by 128 (forward CV 66 and reverse CV 95).

8.3. Motor

8.3.1. DC motor PWM frequency (CV 49)

Here you can select the desired tact frequency for motor control (pulse width modulation). The possible values are 15kHz and 30kHz. LokSound decoders as from V3.5 are normally set to 30kHz.

8.3.2. Load compensation (CV 49, CV 53, CV 54, CV 55 and CV 56)

Load compensation helps to adjust the motor power in case of obstructions such as gradients.

First of all you may decide if you want to use load compensation or not (CV 49). Then you can set the reference voltage (CV 53) and the two control parameters K and I (CV 54 and 55).

Furthermore you can set the impact (effectiveness) of load compensation (CV 56). At 100%, load compensation is active over the entire speed range; at 50% it is only active up to half the maximum speed.

With this setting your locomotives benefit from load compensation at lower speeds while their speed changes prototypically on gradients.

The numbers of values respectively the values themselves are subject to the type of decoder. For useful values please consult chapter X.1 or the user manual of your decoder.

8.3.3. Speed curves (CV 2, CV 5, CV 6, CV 26, ... and CV 67-97)

The field „Speed Curves“ gives you a choice of a three-point-speed curve or a user-defined speed curve.

The three-point-speed-curve is determined by the start voltage (CV 2), the medium speed (CV 6) and the maximum speed (CV 5).

The speed curve has a higher resolution with 28 speed steps. Subject to the selected speed steps you can move the individual speed points up and down with the mouse and adjust them to the most prototypical setting.

The three-point-speed-curve and the individual speed curve with 28 entries are valid for all operating modes: DCC 14, 28 or 128 speed steps, Motorola® format (14 speed steps) or M4; the selected speed curve will always be adapted (interpolated) to the actual speed mode.

With the choice menu „Default“ you can enter a simple linear or exponential speed curve.

8.4. DCC / Analogue

8.4.1. Zimo® manual function (CV 49)

Activates the Zimo® manual function.

8.4.2. Analogue mode (CV 29)

Activates the analogue mode.

8.4.3. Supported analogue modes and settings (CV 50, CV 125, CV 126, CV 127 and CV 128)

In analogue mode load compensation is not active. Therefore by using the appropriate slide control you can adapt the start voltage and the maximum speed separately for AC or DC analogue mode to match the characteristics of your motor or transformer.

Furthermore you can select the functions that should be active in analogue mode (DC, AC or both; CV 50).

8.4.4. Analogue mode F1-F8 / Analogue mode FL, F9-F12 (CV 13, CV 14)

Since most analogue layouts do not have input devices to trigger functions, these parameters allow you to pre-select which functions should be automatically active in analogue mode.

It is recommended to turn on the sound (default value F1) and the smoke generator of steam locomotives (often F4).

Furthermore the headlights in both directions would be switched on in analogue mode (marked as FL(f) and FL(r) in the register). Functions F9 and F10 can also be set as directional functions (F9(f), F9(r), F10(f), F10(r)).



Subwindow „Decoder“

8.5. Sound settings

This window shows the behaviour of all sounds that are related to the movement of the locomotive, also characteristics of Random Sounds and main volume control. However, we are not talking about the actual sound files (wav-files) but the parameters that control these sound files.

Of course these settings must match the type of sound files stored on the decoder. Otherwise some absurd results may occur when for instance steam sounds are stored on the decoder but the settings here are for a diesel locomotive.

On the other hand there is no limit to the creative use of the LokProgrammer for achieving exceptional sound effects. For instance it is quite easy to insert discussions between engineer and fireman, station announcements or even music into the project and to replay them with your LokSound decoder.

8.5.1. Type of sounds (CV 57, CV 58)

Selection of locomotive type (also refer to chapter 3.1.):

- [Diesel locomotive - hydraulic](#)
- [Diesel locomotive with manual transmission](#)
- [Diesel-electric locomotive or electric locomotive](#)

Here it is possible to use only one sound file for driving and to add extra effects with „Interval between Throttle Notches“. It is necessary to set the „Speed of Driving sound“ to the appropriate value (also see 8.5.4) in order to make differences in pitch audible.

„Interval between Throttle Notches“ divides the speed curve into certain sectors in which the driving noise is played at a different pitch. If this parameter is set to „1“ the decoder will play the driving noises without audible throttle notches.

- [Steam locomotives without external wheel sensor](#): the exhaust chuffs can be synchronized with the revolutions of the drivers. The time between the exhaust chuffs is determined by multiplying the value of CV 57 („Interval between Exhaust Chuffs at Speed Step 1“) by 0.064 seconds.

The value of CV 58 („... and at Speed Step 2“) determines the degree of reduction of the time between exhaust chuffs with increasing speed starting at speed step 2.

Since these settings depend on the circumference of the drivers, the selected maximum speed and the motor characteristics they have to be determined by trial and error. The LokProgrammer in conjunction with a test oval provides the best testing conditions.

More info on synchronizing without external sensor can be found in chapter 12.2.

- [Steam locomotive with external wheel sensor](#): Steam locomotives with external wheel sensors are very common in the large scales such as G and 1 gauge. The parameter „Trigger Pulse“ (CV 58) determines after how many pulses from the sensor the exhaust chuff will be played. The decoder differentiates between „On“ and „Off“ pulses. If CV 58 is set to „1“ then the decoder will play an exhaust cuff for each „On“ and „Off“ pulse. Value „2“ triggers an exhaust chuff for each „On“ pulse while value 4 triggers the chuff for every second „On“ pulse. The default value is „2“. In principle the value can be increased up to 250.

8.5.2. Minimum time between exhaust chuffs (CV 249)

Normally exhaust chuffs are speed dependant. However, in case of a somewhat unfortunate configuration of wheel circumference and maximum speed this could lead to an undesirable sound at high speeds rather like a machine gun and not like a steam locomotive.

To counter this effect you can adjust „Minimum Time between Exhaust Chuffs“. The value represents the minimum time between two chuffs even when the maximum speed has not yet been reached.

Of course the chuffs are not synchronized to the drivers any more at that stage but this is hardly noticeable at high speeds.

8.5.3. Random sounds (CV 61, CV 62)

In this field you can activate the Random Sounds and the time intervals between them.

The LokSound decoder plays the Random Sounds arbitrarily within these minimum and maximum intervals. The values correspond with seconds (also refer to 9.5).

8.5.4. Speed of driving sound (CV 59, 60)

These parameters allow you to simulate the revs of the motor. The sound files for the driving sound are the basis. The value is given in %. 100% means original speed of the sound file, 200% twice the speed. The pitch is changed subject to the speed. One could compare this effect with a cassette player that is running too slowly. If you set the value of „...“ at the highest Speed Step“ to 100% then the driving sound will remain constant (provided you have only one sound file for driving).

8.5.5. Brake sound threshold (CV 64)

Here you determine when exactly the decoder starts playing the brake squeal. The higher the value, the sooner the squeal will start.

8.5.6. Sound volume (CV 63, CV 121, CV 122 and CV 123)

The sound volume can be adjusted to match the speaker with the slide controls.

Controls 1, 2 and 3 can be used as group controls. The overall volume (CV 63) influences controls 1, 2 and 3. Control 1 (CV 121) is intended for horns and whistles, control 2 (CV 122) for bells and control 3 (CV 123) for additional sounds. This is only a suggestion. Of course you may use the controls for other sound groups as well. The advantage of the group control is that you could link for instance the driving noise of a steam locomotive to one group in order to be able to adjust the volume of all exhaust chuffs simultaneously should they be too loud or too quiet compared to User Sounds or Random Sounds.

8.5.7. Load dependent sound (CV124)

If the decoder registers a load – i.e.: when load compensation becomes active – the driving noises will be played louder. This works only if the overall volume is set to a lower value than maximum. Only then are some „volume reserves“ available.

8.5.8. Sound steam shift (CV250, CV251, CV252)

One can hear that the chuffs of compound steam locomotives are generated by two drive mechanisms. The LokProgrammer achieves this effect by adding an additional exhaust chuff between the regular ones. This extra chuff continuously changes its timing relative to the regular chuffs.

After activating „Sound Steam Shift“ the following parameters can be edited:

- [Duration of steam shift](#): here you determine how long the shifted chuff needs to go from the earliest possible relative start position to the latest start position and back again. The value entered here is a relative value and must be determined by testing.
- [Earliest relative start position for steam shift](#): in order to avoid that the additional chuff is played at the same time as the regular one and thus would lead to over-modulation of the sound it is recommended to slightly delay the steam shift. This delay is set in this parameter.
- [Latest relative start position for steam shift](#): in order to avoid that the additional chuff is played at the same time as the following regular chuff and thus would lead to over-modulation of the sound it is recommended to bring forward the end of the steam shift. This can be set with this parameter.

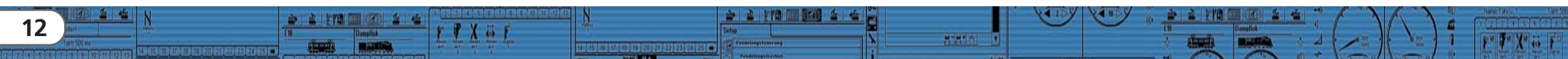

Subwindow „Decoder“

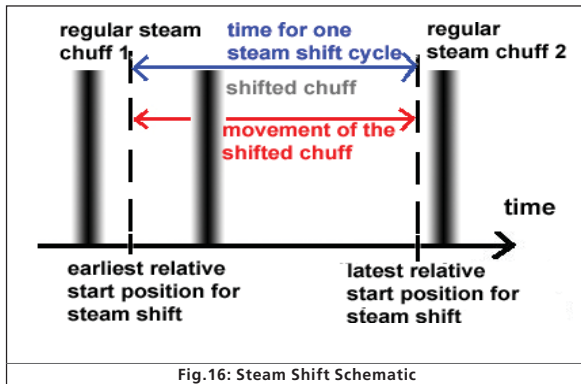

Fig.16: Steam Shift Schematic

8.6. Function mapping

Here you can allocate functions to each function button. Depending on the decoder type there are the function buttons FL and F1 to F15.



Please note that Märklin®-Motorola® systems only support the buttons F1 to F4. F5 to F8, however, can be activated by means of a second address (see 10.4).

Figure 14 provides an overview of possible settings.



For allocating a certain function to a certain button tick the appropriate field at the intersection of the column „Function Button“ and the line „Function“.

Please remember that function mapping is stored in the CVs. Therefore you should always read the decoder data first in order to get to know the current status before making any changes (also see chapter 5.3). The functions are allocated with the CVs 129 – 230 (also refer to 13.1.).

You may allocate several functions to one button. You could for instance trigger a sound effect or other functions every time you switch AUX1.

However, it is not possible to play two or more sounds simultaneously by pressing one function button.



Please note that functions can be allocated separately for forward (f) and reverse (r) motion. Thus the behaviour of some functions can vary subject to direction of travel and / or different sounds could be triggered (e.g.: directional horn signals). If you wish to allocate a function for both directions simply enter the function respectively the sound in both columns of the corresponding function allocation.

8.6.1. Description of the matrix columns

- FS(f), FS(r): Allocated functions and sounds will be activated automatically while the locomotive is standing and thus are not switched with a function button.
- FF(f), FF(r): Allocated functions and sounds will be activated automatically while the locomotive is moving and thus are not switched with a function button.
- FL(F), FL(r): Allocated functions and sounds will be activated via the lighting button of the command station (respectively by F0 in the „Virtual Cab“).
- F1(f), F1(r) to F15(f), F(r): Allocated functions and sounds will be activated via the function buttons 1-15 of the command station.

In the following paragraphs the individual options (lines) in the function mapping register and their effects will be explained.

8.6.2. Head lights, back-up lights

Normally the headlights and back-up lights are wired in such a way that they are switched subject to direction of movement. Set a cross into „Headlights“ at FL(f) and another one for „Back-up Lights“ at FL(r).

Now you can switch the lights with the lighting button of your command station or throttle respectively with „F0“ of the virtual cab. In Fig. 14 you see the default entry for the lights in the columns FL (f) and FL (r) for locomotives with standard wiring.

8.6.3. Aux 1-4

With the aid of AUX outputs you can activate (electro-) mechanical functions of your locomotive (e.g.: smoke generator, pantograph, etc.) in accordance with the wiring.

Please note that decoders with the 8-pole plug support only AUX 1 and 2. Decoders with the 21-pole plug „mtc“ also support AUX 4. XL-decoders have 6 AUX outputs (AUX 1-6).

8.6.4. Acceleration and coasting of diesel locomotives

Here you can play the idle *and* driving sounds while standing still and moving. Activate the function „Accelerate Diesel“ then the decoder shifts from the sound of the current speed step to the sounds of the following higher speed steps until you deactivate this function no matter at what speed or if the locomotive is standing still. The actual speed (or no movement if the locomotive was stationary prior to your first command) remains intact.

When you trigger „Coasting“ then the above sequence will be played in reverse without changing the actual status of movement or standing still.

This function serves to rev the diesel motor while standing or to simulate the sound of a locomotive with a heavy load (for instance on a gradient). This function is only appropriate for diesel-electric locomotives.

It is best to allocate this function to both directions.

Function Outputs		[CV 129 - CV 236]											
		FS (f)	FS (r)	FF (f)	FF (r)	FL (f)	FL (r)	F1 (f)	F1 (r)	F2 (f)	F2 (r)		
Front Light		<input type="checkbox"/>	<input type="checkbox"/>	<input type="checkbox"/>	<input type="checkbox"/>	<input checked="" type="checkbox"/>	<input type="checkbox"/>	<input type="checkbox"/>	<input type="checkbox"/>	<input type="checkbox"/>	<input type="checkbox"/>		
Rear Light		<input type="checkbox"/>	<input type="checkbox"/>	<input type="checkbox"/>	<input type="checkbox"/>	<input type="checkbox"/>	<input checked="" type="checkbox"/>	<input type="checkbox"/>	<input type="checkbox"/>	<input type="checkbox"/>	<input type="checkbox"/>		
AUX1		<input type="checkbox"/>	<input type="checkbox"/>	<input type="checkbox"/>	<input type="checkbox"/>	<input type="checkbox"/>	<input type="checkbox"/>	<input type="checkbox"/>	<input type="checkbox"/>	<input type="checkbox"/>	<input type="checkbox"/>		
AUX2		<input type="checkbox"/>	<input type="checkbox"/>	<input type="checkbox"/>	<input type="checkbox"/>	<input type="checkbox"/>	<input type="checkbox"/>	<input type="checkbox"/>	<input type="checkbox"/>	<input type="checkbox"/>	<input type="checkbox"/>		
[AUX3]		<input type="checkbox"/>	<input type="checkbox"/>	<input type="checkbox"/>	<input type="checkbox"/>	<input type="checkbox"/>	<input type="checkbox"/>	<input type="checkbox"/>	<input type="checkbox"/>	<input type="checkbox"/>	<input type="checkbox"/>		
[AUX4]		<input type="checkbox"/>	<input type="checkbox"/>	<input type="checkbox"/>	<input type="checkbox"/>	<input type="checkbox"/>	<input type="checkbox"/>	<input type="checkbox"/>	<input type="checkbox"/>	<input type="checkbox"/>	<input type="checkbox"/>		
Diesel notching up		<input type="checkbox"/>	<input type="checkbox"/>	<input type="checkbox"/>	<input type="checkbox"/>	<input type="checkbox"/>	<input type="checkbox"/>	<input type="checkbox"/>	<input type="checkbox"/>	<input type="checkbox"/>	<input type="checkbox"/>		
Diesel notching down		<input type="checkbox"/>	<input type="checkbox"/>	<input type="checkbox"/>	<input type="checkbox"/>	<input type="checkbox"/>	<input type="checkbox"/>	<input type="checkbox"/>	<input type="checkbox"/>	<input type="checkbox"/>	<input type="checkbox"/>		
Acceleration/Brake Time		<input type="checkbox"/>	<input type="checkbox"/>	<input type="checkbox"/>	<input type="checkbox"/>	<input type="checkbox"/>	<input type="checkbox"/>	<input type="checkbox"/>	<input type="checkbox"/>	<input type="checkbox"/>	<input type="checkbox"/>		
Shunting Mode/Shunting Speed		<input type="checkbox"/>	<input type="checkbox"/>	<input type="checkbox"/>	<input type="checkbox"/>	<input type="checkbox"/>	<input type="checkbox"/>	<input type="checkbox"/>	<input type="checkbox"/>	<input type="checkbox"/>	<input type="checkbox"/>		
Sound on/off		<input type="checkbox"/>	<input type="checkbox"/>	<input type="checkbox"/>	<input type="checkbox"/>	<input type="checkbox"/>	<input type="checkbox"/>	<input checked="" type="checkbox"/>	<input checked="" type="checkbox"/>	<input type="checkbox"/>	<input type="checkbox"/>		
Shift Mode		<input type="checkbox"/>	<input type="checkbox"/>	<input type="checkbox"/>	<input type="checkbox"/>	<input type="checkbox"/>	<input type="checkbox"/>	<input type="checkbox"/>	<input type="checkbox"/>	<input type="checkbox"/>	<input type="checkbox"/>		
Fan Sound		<input type="checkbox"/>	<input type="checkbox"/>	<input type="checkbox"/>	<input type="checkbox"/>	<input type="checkbox"/>	<input type="checkbox"/>	<input type="checkbox"/>	<input type="checkbox"/>	<input type="checkbox"/>	<input type="checkbox"/>		
Doppler		<input type="checkbox"/>	<input type="checkbox"/>	<input type="checkbox"/>	<input type="checkbox"/>	<input type="checkbox"/>	<input type="checkbox"/>	<input type="checkbox"/>	<input type="checkbox"/>	<input type="checkbox"/>	<input type="checkbox"/>		
Volume Control / Mute		<input type="checkbox"/>	<input type="checkbox"/>	<input type="checkbox"/>	<input type="checkbox"/>	<input type="checkbox"/>	<input type="checkbox"/>	<input type="checkbox"/>	<input type="checkbox"/>	<input type="checkbox"/>	<input type="checkbox"/>		
Dynamic Brake		<input type="checkbox"/>	<input type="checkbox"/>	<input type="checkbox"/>	<input type="checkbox"/>	<input type="checkbox"/>	<input type="checkbox"/>	<input type="checkbox"/>	<input type="checkbox"/>	<input type="checkbox"/>	<input type="checkbox"/>		
Sound Slots		<input type="checkbox"/>	<input type="checkbox"/>	<input type="checkbox"/>	<input type="checkbox"/>	<input type="checkbox"/>	<input type="checkbox"/>	<input type="checkbox"/>	<input type="checkbox"/>	<input type="checkbox"/>	<input type="checkbox"/>		

Fig.17.: Function Outputs Matrix

Subwindow „Decoder“

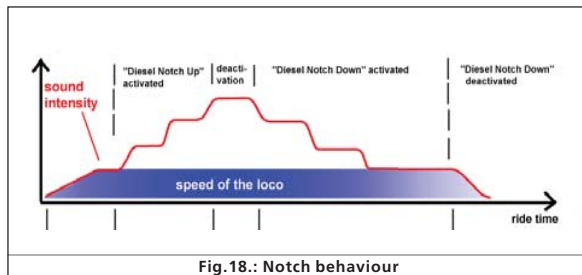

Fig.18.: Notch behaviour

8.6.5. Acceleration / Deceleration

This function turns off the delay in accelerating or slowing down as set in the window „Driving Characteristics“ (also refer to 8.2.3.).

This is useful when the locomotive is set to shunting mode and therefore should respond quicker to your commands.

It is best to allocate this function to both directions.

8.6.6. Shunting mode

This function reduces the speed to half of the current speed. It is recommended to allocate the shunting mode to the same function as the acceleration / deceleration. It is best to allocate this function to both directions.

8.6.7. Sound on / off

With this you activate all driving noises and all other sounds that depend on the driving noises. It is best to allocate this function to both directions.

8.6.8. Shift mode

All alternative sound slots that are parallel to the regular sounds are activated with shift mode. When shift mode is active all regular sound slots are deactivated (also refer to chapter 9.7.). Pure (electromechanical) functions are affected by this.

8.6.9. Fan sound

This function activates the sound channel for the fan that runs parallel to the actual driving noise. This function is particularly useful for electric locomotives where you can hear the fan continuously in the background.

It is best to allocate this function to both directions.

8.6.10. Doppler effect

This function simulates the so called Doppler Effect as it is heard when a train is moving away very quickly. This function is most useful in combination with the sound of a horn or a whistle activated with the same function button (how to activate the Doppler Effect during operation is described in chapter 13.1.1.).

It is best to allocate this function to both directions.

8.6.11. Volume / Mute

With this function you can mute the sound and – by double clicking – you can set 4 different levels of the overall volume. It is best to allocate this function to both directions.

8.6.12. Dynamic brake

In order to simulate this function, that is often present in diesel and electric locomotives, as close to the original as possible the acceleration and deceleration is reduced to half the time. It is best to allocate this function to both directions.

8.6.13. Sound slots

Here you enter the numbers of the desired user sound slots. If you have already imported some user sound slots then you can click onto the corresponding square with the right mouse button. A choice list appears showing all occupied sound slot numbers and the corresponding sound files.

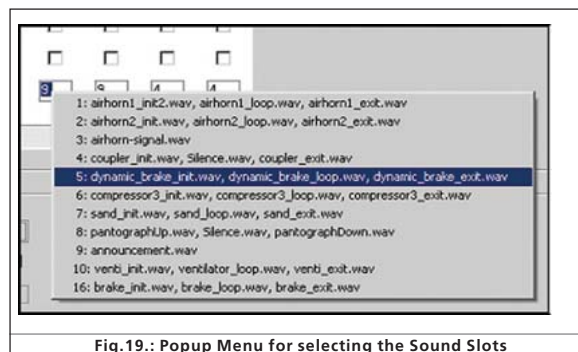

Fig.19.: Popup Menu for selecting the Sound Slots

8.6.14. Configuration of outputs..... (lights and AUX-outputs) (CV 113- CV 120)

This parameter allows you to adjust the type and intensity of physical outputs.

The available choices are:

- **Dimmer:** uniform voltage is available at the output for operating constant functions.
- **Blinking light (Phase 1) / Blinking light (Phase 2)**
- **Strobe:** Stroboscopic effect
- **Double Strobe:** Stroboscopic effect with double blinking
- **Fire box:** generates flickering light for the imitation of the open fire box. This function makes sense in conjunction with the sound of shovelling coal.
- **Smoke generator:** while the locomotive is stopped a smoke generator only heats to a limited degree when operating in conjunction with driving noises. However, it operates to its maximum in synchronization with the exhaust chuffs during movement. If you wish to simulate a uniform amount of smoke coming out of the chimney it is recommended to set the output function for the smoke generator to „Dimmer“.

- **Fade lights up and down:** contrary to the setting „Dimmer“ the lights do not appear at full brightness immediately but are slowly fading up respectively down.
- **Mars light:** Simulation of a blinking warning light mainly used on American locomotives.
- **Gyro light:** Simulation of a rotating beacon.
- **Rule 17 forward / rule 17 back-up:** simulates a dimming method of American headlights.
- **Pulse (limited time):** lights up when activated and switches off after a certain time automatically. The „Switch-on Period“ is set with the „Brightness“ controller.
- **Ditch light (Phase 1) / ditch light (Phase 2):** Setting for additional headlights for American locomotives

8.6.15. Blinking frequency of strobe effects (CV 112)

The time can be set between 0.262 seconds (value 4) up to 4.194 seconds (value 64) and affects all blinking effects.

8.6.16. Activate LGB® mode (CV 49)

All ESU decoders except M4 can be operated with the LGB multiple train control system (MIZS). This mode must be activated here prior to use.

8.6.17. Behaviour of function buttons (LokSound 2 mode) (CV 49)

In LokSound 2 mode all sounds and functions will be activated whenever the function button is pressed (on or off).

8.6.18. Märklin® delta mode (CV 49)

Here you can set the decoder for operation with Märklin® Delta-devices.

8.7. Manual CV entry

The LokProgrammer software offers all CVs at a glance. In this display you can adjust all CVs in decimal values and save the CV list as a text document.

Change CVs manually:

- Click onto the field with the decimal values of the CV you want to change
- Enter the new value
- Click onto the button „Check Values and Accept“.

Export CV-List as text file:

- Click onto the button „Export...“
- Save the file as .txt-file in the desired folder
- Now you can read and print this file with any text processing program. Changes in this document do not affect the project file in the LokProgrammer.

8.8. Special options (CV 124)

Here you can pre-select certain options so they are available after an interruption of power on your layout.

- „Save Direction of Travel“ activates the so called „Directional Bit“, a Märklin®-specific term that refers to the layout-specific direction of travel.
- „Save Status of Function Buttons“ assures that all functions recommence their status after an interruption of power.
- „Save Current Target Speed“ preserves the „old“ speed in the decoder.
- When „Accelerate after a Reset with the Programmed Delay“ is set, the locomotive will accelerate as per the programmed parameters; otherwise it will „jump-start“.



If a decoder supports these options is subject to the version of the decoder firmware.

8.9. Identification (CV 7, CV 8)

This read-only option provides the manufacturer's ID (CV 8) and the internal version number of the decoder firmware (CV 7). The manufacturer's code of ESU is „151“. If you write the value „8“ into CV 8 then you trigger a factory-reset (default values) but do not delete the manufacturer's ID. The value of CV 8 will always remain at „151“. Entering value „8“ simply triggers the reset.



All LokSound types offer two user fields for any personal codes, etc. in („User-ID 1“ and „User-ID 2“).

9. Sounds

In 1999 the very first LokSound „classic“ decoder already offered the feature to store real sounds and to change them at will or replace them with completely different ones. Since then each LokSound decoder is a platform for all sorts of sound sequences that may occur when operating railways. This universal and very flexible concept even allows to store and replay music or voices besides the typical railway sounds. There is no limit to your imagination.

In order to make sure that you can utilize the multiple features of the LokSound decoders to the optimum we will explain below first the general concept of the sound module of LokSound decoders and then the specific methods of the software. You should make a point of reading this introduction before you start any specific sound project. Without understanding the concept you may not fully realize the potential of the software.

We explain the concept based on the LokSound decoder version 3.5. This is also valid for LokSound micro and LokSound XL. M4 offers at least partially different features that are described in chapter 10.

Older LokSound 2-decoders have perhaps less functions to offer, but the principle remains the same. Since the LokSound 2 decoder is no longer manufactured it will not be dealt with in this manual.

9.1. Concept of LokSound

The decoder has an internal memory chip with 8 MBit (LokSound hardware 3.3) or 16 MBit (LokSound hardware 3.5) capacity. This is enough for 69 respectively 138 seconds of digital sound.

In order to achieve a continuous sound that does not stop after 69 seconds we have to use a few tricks: the memory contains only a short fragment of the motor sound (about half a second). This fragment is played as a loop in the LokSound decoder thus generating continuous sound.

Such tricks enable us to utilize the memory space to the optimum. The number of sounds is not pre-determined and is only limited by the size of the memory.

Generally this is sufficient to store all necessary sounds for a locomotive. A simple steam locomotive can be equipped with sound with only 20 seconds of sound fragments. That includes the bell, whistle, air pump, etc.

There are three categories of sounds: Driving sounds, Random Sounds and User Sounds (sounds that are triggered by the user).

The LokSound decoder works with a „schedule“. It contains all information such as when to play which sound.



The different stages are connected with arrows and thus represent the possible changes from one stage to the next. The driving noises are stored in so called sound slots and are called up according to the pre-determined speed of the locomotive.

Sound Fragments of varying number are entered into the Sound Slots. There must be at least three sound fragments in each sound slot. These three standard sound fragments are generally used as start, middle and end part of the respective sound (also refer to 9.2.1.). The sound fragments do not have to fill the available memory space completely. At certain points (for instance within a throttle notch) it only makes sense to enter the sound loop of the motor.

Whenever the LokSound module undergoes a change of status the sound fragments in the corresponding sound slots will be played.

If there should be no sound at a certain stage or change of status then the corresponding field of the sound slot must remain empty.

Empty sound slots are displayed in white while sounds slots that contain sound fragments are displayed in blue.

Random Sounds are stored in „Extra Sound Slots“ and will be played according to the settings in the register „Decoder“ (also refer to chapter 8.5.3).

User Sounds are also stored in their own sound slots. These sound slots are allocated to the desired function buttons in function mapping (also refer to 8.6.).

9.2. Basic methodology for working in the „Sound“ register

9.2.1. Nomenclature

For your better understanding we have defined the terminology for the three fields within a sound slot in the following chapters as outlined below:

- The starting part is called „Init“(„initial“)
- The middle part is called „Loop“
- The final part is called „Exit“

These terms relate to the standard application of these fields for ESU products (also refer to chapter 12). Regardless of the terminology you could for instance enter a loop sound into the Init field (also refer to 9.6.).



For each of the three parts of a sound slot you can use different sound files that are then played by the decoder in sequence.

We call the groups-of-three in the data entry fields sound Slots. They are located within the squares in the project schedule and in the windows „Random Sounds“ and „User Sounds“.

9.2.2. Importing / Deleting sounds in projects

Figure 17 shows the lower part of the view „Sound“. In the right column („Project Sounds“) are all the sounds listed that have already been imported into the project, in other words that are to be stored in the memory.

At the bottom of the left column („Folder“) you see a data tree of all folders on the hard disc of your PC. Besides the folder this also shows the audio files and esu.-files. If you click onto an ESU file the data tree is expanded and shows the sound fragments that are already contained in the sound files (.wav).

In order to import a sound file or sound fragment from the folders on the hard disc of your PC (or from the CD-ROM supplied with the LokProgrammer) you proceed as follows:

- Mark the file with a mouse click, keep holding the mouse button.
- Drag the file with the mouse from the folder into the window „Project Sounds“. Now the desired file appears in the list of project sounds.



Sound

In order to remove a sound file from the list, proceed as follows:

- Mark the file with a mouse click in the column „Project Sounds“.
- Delete the file with the „Del“ button on your keyboard.

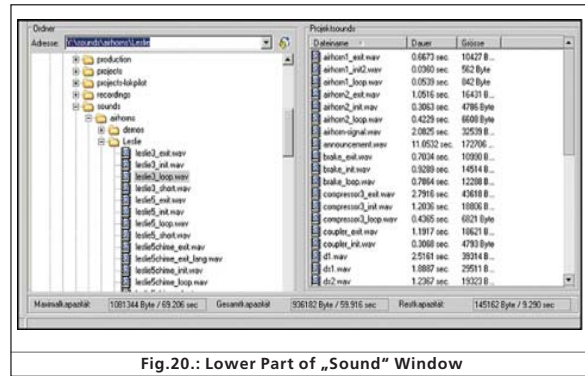

Fig.20.: Lower Part of „Sound“ Window

9.2.3. Allocate / Delete sounds to (from) sound slots

All sound fragments that you want to allocate to different sound slots must first be imported into the list „Project sounds“. Only sounds from that list will ultimately be transferred to the LokSound module.

A sound is allocated to a sound slot by doing the following:

- Open a square (throttle notch, random sound or user sound) to which you want to allocate a sound with a mouse click.
- A pop-up window opens as shown in Fig. 21.
- Mark the desired file in „Project Sounds“ and keep holding the mouse button.
- Drag the sound into the desired field in the pop-up window.

A simple option of allocation:

- Mark the desired .wav file in „Project Sounds“
- Drag the file onto the desired (but yet unopened) square. The sound will be automatically imported into the „Loop“. The square changes its colour from white to blue.
- This option is only suitable for sounds that have to be imported into the loop section of the sound slot anyway (e.g.: driving noises in loop mode or individual user sounds without Init- or Exit-part).

In order to delete an allocation, proceed as follows.

- Open the desired sound slot by a mouse click
- Mark the file name of the sound to be deleted within the sound slot
- Delete the allocation by pressing „Del“ on the keyboard. The allocation will be deleted but not the file in the list „Project Sounds“. Thus this sound may still be used within the project.

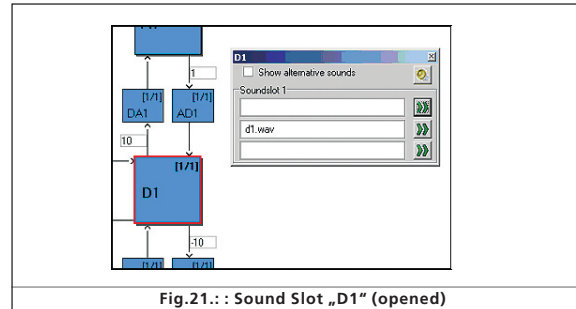

Fig.21.: Sound Slot „D1“ (opened)

9.2.4. Extended functions in the „Sound“

At the top left corner of this window there is another tool bar with the following functions:



Set project as steam locomotive. This button is linked to the parameter „Type of Sound“. (also refer to 8.5.1.).



Set project as diesel locomotive. This button is linked to the parameter „Type of Sound“.



Set project as electric locomotive. This button is linked to the parameter „Type of Sound“.



Edit motor. You can see and edit the schedule of the driving noises. This button is active for all locomotive types.



Edit fan motor. The schedule of the fan sound channel will be opened (also refer to chapter 9.3.2.).



Further settings: Here you can edit auxiliary functions that relate to the schedule of steam locomotives and user sounds. Thus you can set user sound slot 16 for the braking sound. User sound slot 15 can be used for an automatically triggered sound after the locomotive has stopped, such as an air pump of steam locomotives. User sound slot 14 can be used for shift sounds (for instance for diesel locomotives with mechanical transmission). This does not only play the sound of shifting gears but also the prototypical change of the revs of the locomotive (also refer to 9.6.).

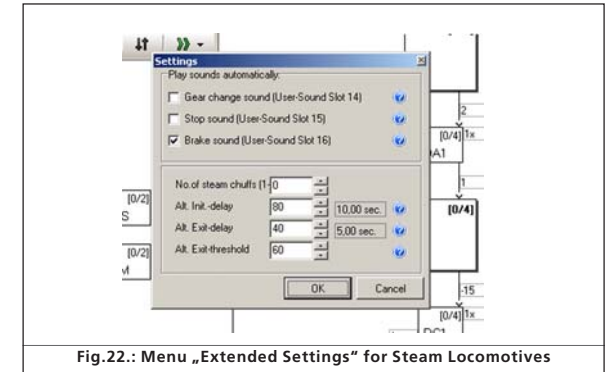

Fig.22.: Menu „Extended Settings“ for Steam Locomotives



For diesel and electric locomotives only the field „Trigger Sounds Automatically“ is available.



Add throttle notches. Depending on the number of different available throttle notch sounds you can import up to 5 for steam locomotives or up to 10 for diesel and electric locomotives. These throttle notches do not correspond with the 12 resp. 28 or 128 speed steps of the digital protocols. The throttle notches of your sound schedule will be equally divided across the entire speed range of your command station.

Import at least one sound file into all throttle notches you want to use otherwise one could hear a silent gap between throttle notches when the locomotive is running.

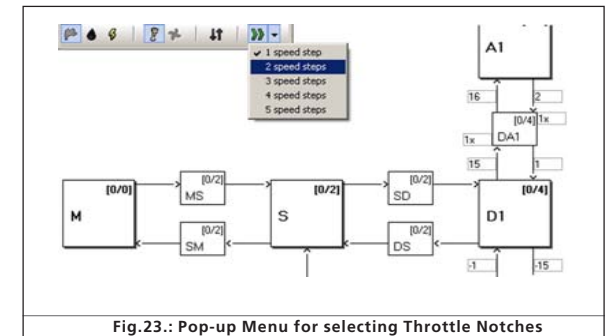

Fig.23.: Pop-up Menu for selecting Throttle Notches

9.3. Schedule

This and the following chapters outline the rules and possibilities regarding the composition of sounds.

After having imported various sounds into the sound slots it is necessary to determine when each sound should be played. All necessary information is contained in the schedule. 9.3. Ablaufplan.

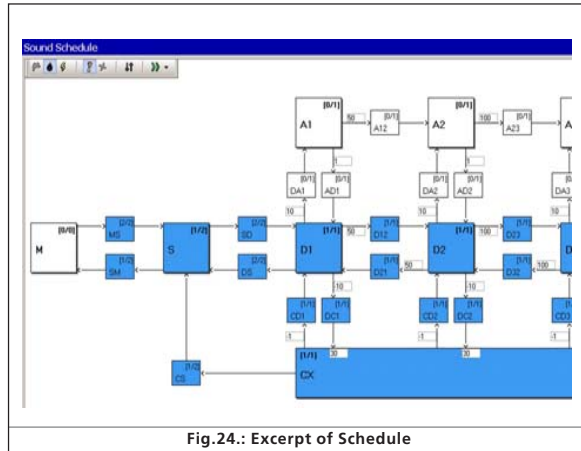

Fig. 24.: Excerpt of Schedule

9.3.1. Schedule for running (driving) sounds

This displays a graphic representation of all possible states of a locomotive:

- **„M“** (=“Mute“ or silent) stands for a stationary locomotive with the sound turned off. No sounds have to be imported here.
 - **„MS“** (=“Mute to stop“) stands for a stationary locomotive with the sound turned on. This sound slot has two fields that will be played in sequence (if they are both filled). This enables you to play a two-part sound with one start, middle and end part each simulating the starting of the motor. Here you would import the sound of the starting diesel engine or the raising of the pantograph of an electric locomotive.
 - The sound slot **„SM“** (=“Stop to mute“) contains „parking“ sounds such as turning off the diesel motor or lowering the pantograph. You could also add a valve releasing compressed air. There is no limit to what sounds you might want to play.
 - **„S“** (=“Stand“) stands for a stationary locomotive with the sounds in idle (e.g.: the hiss of steam or the sound of an idling diesel motor). There are two sound parts. It is important to know that all sounds in step 2 are automatically played in loop mode. However, you can change this if needed.
 - In the stages **„Dx“** (=“Drive“), the locomotive is moving and plays the appropriate sounds. „x“ indicates the number of the throttle notch.
- Depending on the type of locomotive there may be up to 10 „D“ notches. Thus it is possible to allocate the sound recordings of different notches to the corresponding speeds of the locomotive.
- Status **„A“** (=“Acceleration“) is reached when the locomotive accelerates. For the decoder acceleration means the target speed is higher than the actual speed.



An example: Acceleration of the locomotive has been set to 10 seconds. The locomotive is moving slowly and you turn up the throttle to maximum. Then the locomotive will accelerate according to the corresponding settings for acceleration. During this phase only the sounds imported into sound slot „A“ will be played.

Thus it is possible to use particularly powerful exhaust chuffs or a hard working diesel motor during acceleration. In sound slot „A“ the appropriate sounds for each speed (notch) will be played. Depending on the type of locomotive up to 10 „A“ notches are available. As soon as the target speed is reached the decoder shifts into stage „D“.

- **„CX“** (=“Coast“) is reached when the throttle is turned back and the locomotive is coasting. Similar to the acceleration delays that affect sound slot „A“ the braking delays affect sound slot „CX“.
 - There are also transition notches since the transition from one sound loop to the next would otherwise be to abrupt.
 - **„DA“** (=“Drive to acceleration“) is the transition between driving at constant speed and acceleration. Here one could place a howl of a motor when it starts revving up.
 - **„AD“** (=“Acceleration to drive“) is the transition from acceleration back to driving at constant speed. This driving step is not available for steam locomotives since we use the same chuffs for DA and AD.
 - **„DC“** (=“Drive to coast“) is the transition from driving to coasting.
 - **„CD“** (=“Coast to drive“) is the transition from coasting to driving. This step is not available for steam locomotives since we use the same chuffs for DC and CD.
- Please note that you have to import one transition for each driving notch to avoid any hard transitions or „crackling“ noises.
- **„SD“** (=“Stop to drive“) is the sound at start of movement. The two sound fragments are played in sequence in different states of motion: the first sound is played shortly before the start, when the locomotive is still stationary; the second part is played just after the locomotive started moving. The division into two parts is particularly meaningful for howling diesel motors or humming electric motors; it generates a very prototypical impression of movement and its associated sound.
 - **„DS“** (=“Drive to stop“) is the transitional sound of the motor during stopping.
 - **„CS“** (=“Coast to stop“) is the transition from the coasting sound to the stop sound (locomotive has stopped, motor is still running). Often there is no audible change between CX and S. Import the sound for idle into CS in order to avoid an audible gap in the schedule.

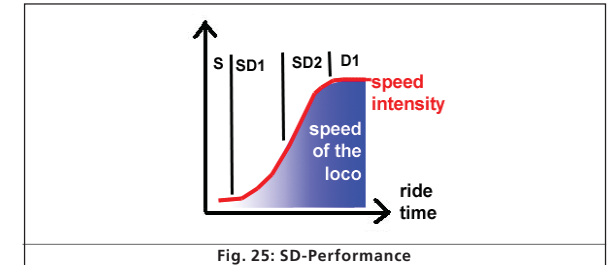



Fig. 25: SD-Performance

- In diesel and electric locomotives there are two more transitions, namely **„Dxy“** and **„Dyx“**; „x“ stands for the number of the previous drive notch and „y“ for the number of the following one.

Should you not wish to utilize the option of having different sounds for acceleration and slowing down (perhaps because you do not have any suitable sound fragments) then you can lock the sound slots „A“ and „CX“ (also refer to 9.3.3.) or you can use the same settings as in sound slot „D1“. Sound slot „D1“ must have an entry otherwise no driving noises will be played at all.

9.3.2. Schedule for fan sounds

In most electric locomotives there is a fan which runs parallel to the traction motors. Therefore we have introduced a separate schedule for the fan sounds that can be opened with the button  in the small tool bar in the „Sound“ register. This schedule contains one step for the stationary locomotive as well as four driving notches for the moving locomotive. These 4 driving notches are independent of the notches of the driving noises and are equally divided over the entire speed range.

- The driving notches **„M“**, **„MS“**, **„SM“** and **„S“** describe the same stages as in the schedule for running.
- **„Rx“** stands for the fan notches with „x“ being the number of the individual notches. There are 4 driving notches for the fan equally divided over the entire speed range. If you want to run up the fan to maximum speed then you must enter sound fragments into all „R“ driving steps. If you want the fan to remain at a constant level from a certain speed onwards you must import the same sound fragments into the remaining „R“-running steps to avoid an audible gap.
- **„SR“** respectively **„RS“** are the transitional running notches between start and stop (analogue to „SD“ and „DS“ in the schedule of the driving noises).
- **„Rxy“** respectively **„Ryx“** are (analogue to „Dxy“ and „Dyx“) the transitional running notches between the individual fan running notches with „x“ being the number of the previous running notch and „y“ for the following one. Of course you can import other parallel driving noises into the fan schedule if you wish to do so.

Thresholds on the sound schedule

9.3.3. Thresholds in the schedule for running (driving) sounds

In order to be able to play the driving noises correctly for each situation the LokSound decoder uses thresholds. These thresholds define the limits where the sound should change. The LokSound decoder differentiates between two types of thresholds:

- Thresholds that divide the speed values between stop and the maximum speed. These values range from 0 to 255 and are shown in a horizontal arrangement in the driving sound schedule.
- Thresholds that work according to the difference between target speed and actual speed. Here the decoder compares the current speed of the motor with the target speed as given by the command station resp. the throttle. These thresholds become effective whenever the locomotive accelerates or slows down and have a range between -128 to 127 (including 0).
- Time parameters that determine the time between idle and re-entry of the driving sound. The following illustration provides an overview on how to deal with thresholds:

Example: Your project has 4 driving notches that are equally divided over the entire speed range between 0 and 255 („63“ between D1 and D2, „127“ between D2 and D3, „191“ between D3 and D4). You slowly increase speed in DCC mode (DCC 28). The driving sounds will change between driving notch 7 and 8, 14 and 15 and 21 and 22 provided the speed curve is linear.

The value 15 has been entered between step D1 and DA1 (also refer to Fig. : 26). You drive your locomotive in speed step 1 (DCC 28 mode) and then accelerate to speed step 10 (this roughly corresponds with the internal value 91). The difference of the internal values between target speed and actual speed is about 82 (for a range from 0 – 255 instead of 0 – 28) and therefore greater than 15. Thus the decoder changes from D1 to DA1 and subsequently to A1 because the difference is also greater than 16.

The decoder accelerates and passes the threshold between D1 and D2. Furthermore it continuously reduces the difference. Once the difference is less than 2 the decoder changes again to the corresponding DA step (in our case DA2) and reaches D“ once the difference is less than 1.

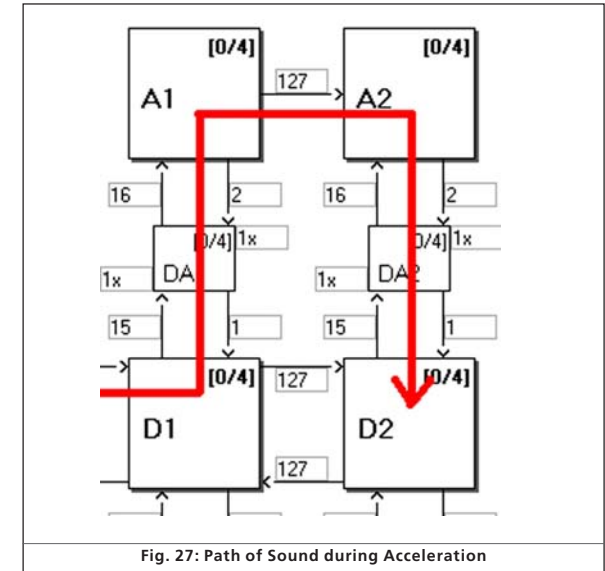

Fig. 27: Path of Sound during Acceleration

The decoder changes the sound speed step from 1 to 2 when reaching appr. half the speed (127 of 255)

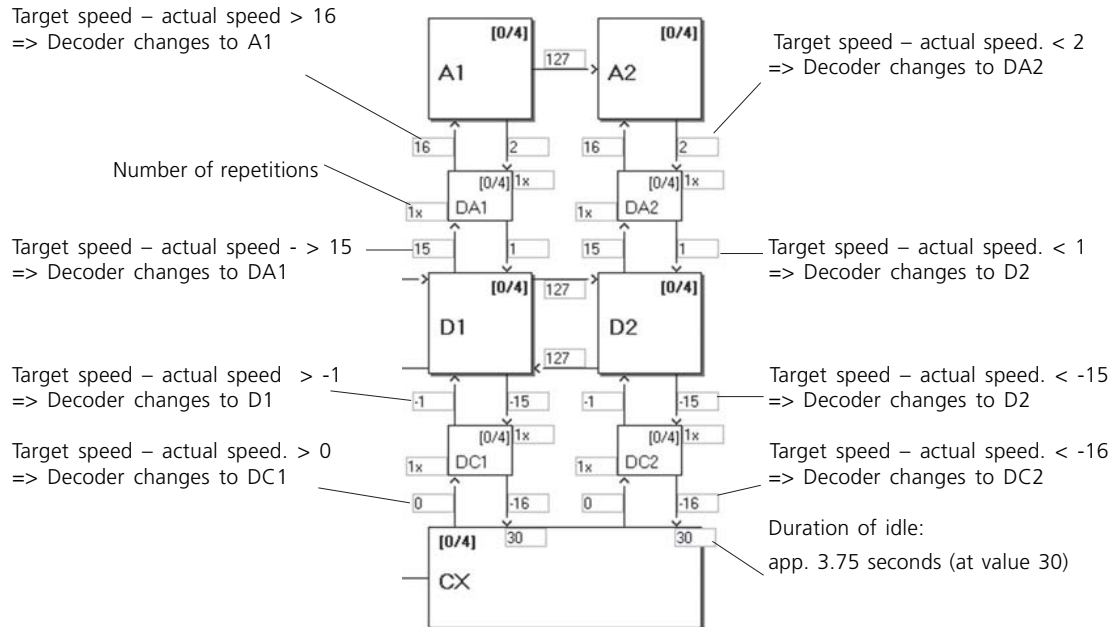

Fig.26.: Thresholds

9.4. Setting the schedule

9.4.1. Soundslots in detail

As soon as you click onto any square of a sound slot with the mouse a pop-up window opens as shown in figures 28 and 29. In order to make editing very easy this window shows the individual sound slots in detail.

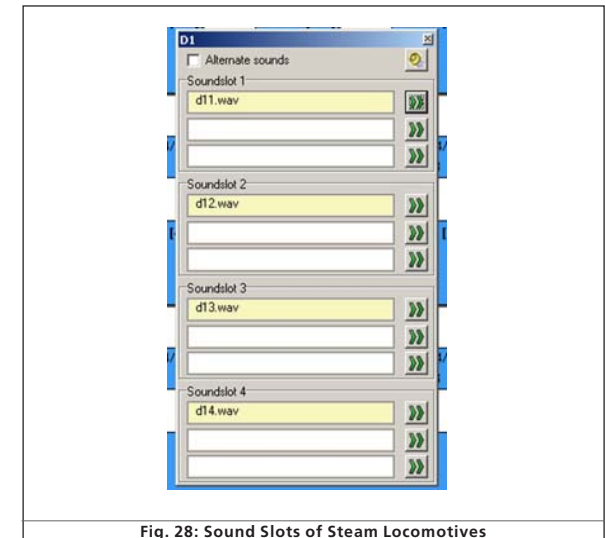

Fig. 28: Sound Slots of Steam Locomotives

Sound configuration

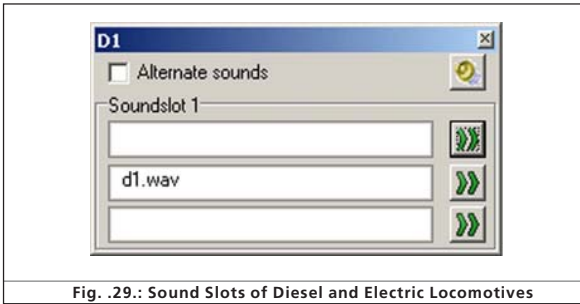

Fig. .29.: Sound Slots of Diesel and Electric Locomotives

The pop-up window can be moved across the screen as desired and always shows the content of the selected square. The currently open square is also marked with a red frame in the schedule.

The sound slots of the driving sounds vary with the type of locomotive. A driving notch of a diesel locomotive or an electric locomotive contains only one sound slot since only one sound loop is required. The driving notches of a steam locomotive contain 4 sound slots to allow for up to for exhaust chuffs per wheel turn (this is subject to the number of cylinders of the prototype) and the following hiss of the steam.

You must set the number of cylinders of the prototype in the menu „Extended Settings“ prior to the adjustments here. Otherwise there may be an audible gap.

9.4.2. Sound settings

Besides the mere allocation you can make additional adjustments for each sound slot:



For this there is a button called „Sound Settings“ which is located next to the actual sound slot allocation. Fig. 30. Shows „Sound Settings“ and „Extended Sound Settings“.

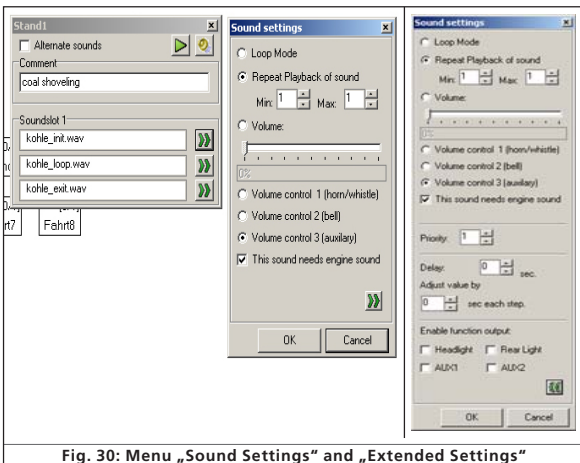

Fig. 30: Menu „Sound Settings“ and „Extended Settings“



In this menu you can select if you want to play this sound as a loop, only once or in a certain number of repetitions.

You can define a minimum and maximum number of repetitions. If the sound should be repeated by a definite number simply enter the same number in both fields. Thus you can enter the definite value „1“ for transitions and choose „Loop Mode“ for driving sounds and the stationary sounds (also refer to 12.3.).

Volume: Use the slide control to adjust the volume of each sound individually or by clicking onto control 1, 2 or 3 in order to allocate it to a group (with equal volume) (also refer to 8.5.6.).

With „Adapt Sound to Driving State“ you determine if the „revs“ of the sound should be modulated in accordance with the increasing revolutions. The maximum revs are predetermined in the „Decoder“ register under „Sound Settings“ (also refer to 8.5.4.).



If you perhaps wish to modulate the revs in the driving sound together with a constant fan sound in the background simply select „Adapt Sound to Driving Noise“ in the slots of the driving sound but not in the slots of the fan sound (also refer to 9.3.).



The button „Volume“ (all slots) controls the volume of all slots and allocations of the selected notch in one step and enables you to select modulation options.

For more information regarding the field „Display Alternative Sounds“ continue reading in chapter 9.7.

9.5. Random sounds

Behind the symbol „Random Sounds“ are a total of 16 squares / sound slots (compare with Fig. 31). Here you can import up to 8 sounds each for a standing or moving locomotive that will be played arbitrarily at different time intervals while the locomotive is stationary or moving. The time frame is adjusted in the „Decoder“ register under „Sound Settings“ (also refer to 8.5.3.). Which sound is played and in what sequence cannot be predetermined. Therefore the sequence will change all the time.

Here you might import sound fragments such as shovelling coal, releasing steam, air or water pumps, etc..

For sounds that should be repeated (e.g.: shovelling coal several times in a row) enter a minimum and maximum number of repetitions in „Sound settings“. Never choose „Play Sound in a Loop“ since the sound would continue until you turn off the power.

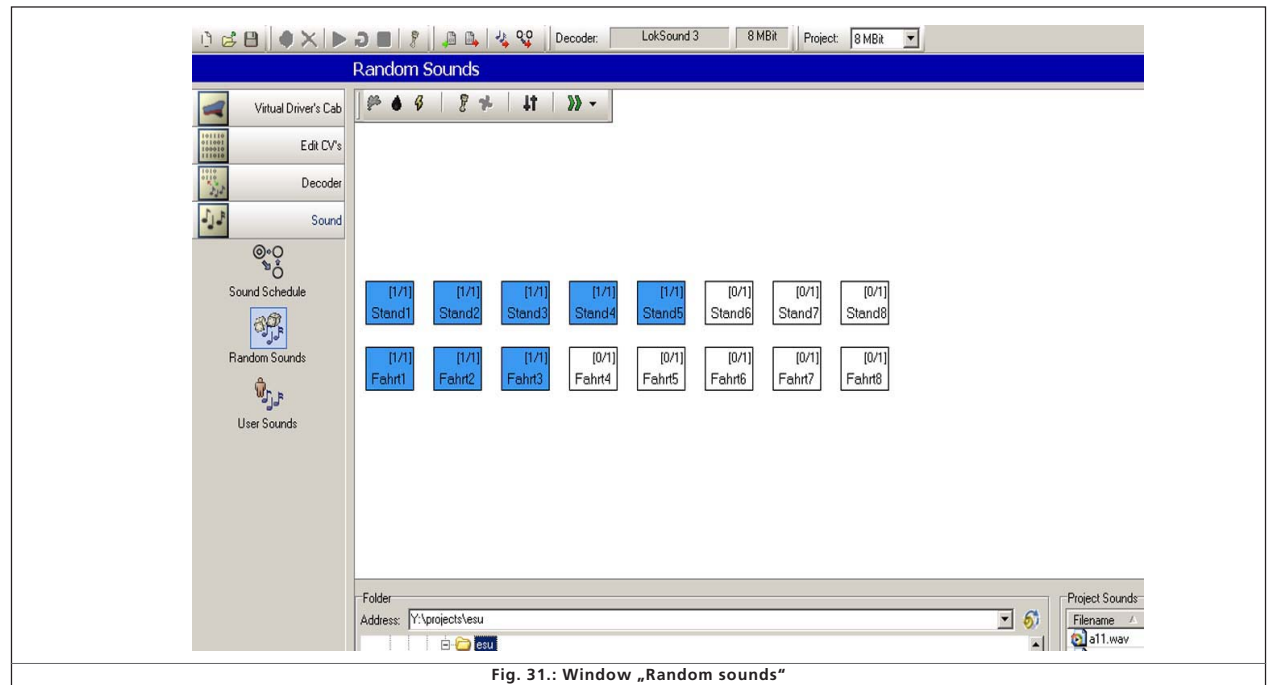

Fig. 31.: Window „Random sounds“

User Sounds



It is possible to allocate function outputs to Random Sounds. This can be done by pressing the button „Display Extended Settings“ in an extension of the window „Sound Settings“. This button is located at the right bottom corner of the window „Sound Settings“.

These outputs will be activated as long as the sounds are played. This enables you for instance to let the firebox light up as long as you hear fireman Fred shovelling coal.

Furthermore you can set a time delay between individual sounds. This time can be adjusted in steps of one second each after which the imported sound is played. This time delay can be increased or reduced for each repetition (in case of several repetitions). Enter a value in the field „Then Change the Value by“. If this value is 0 then the time delay remains constant.

With this time delay you can simulate for instance air pumps that start off very fast and become slower with increasing air pressure.

It also helps to save memory space that would otherwise be filled with „silent“ sound fragments to facilitate the delays.

In the window „Extended Sound Settings“ you can choose the priority of each sound. This determines which random sound or user sound gets priority in case all 4 sound channels are engaged.

If the decoder selects a random sound with a higher priority than sounds that are already playing and if all sound channels are already engaged then the sound with lower priority will be interrupted and the one with higher priority will be played.

Driving sounds always have highest priority. User Sounds are normally played with second highest priority while Random Sounds have the lowest priority. The priority is expressed by values ranging from 1 (lowest priority) to 15 (highest priority). Random Sounds have normally priority 1 or 2.



9.6. User sounds

9.6.1. General settings

Besides the sounds that depend on the status of the locomotive (stationary or moving) the LokSound decoder offers the option of sounds that can be triggered by pressing a button on your command station or throttle. There are a total of 16 sound slots for user sounds as shown in the following illustration.

You can enter one sound sequence into each of these sound slots that can be triggered (almost) by any function button (also refer to 8.6.).



Furthermore you can select in the window „Sound Settings“ if the sound should be played every time you press the corresponding function button once or if it should be played as long as you press the button.

Thus you can for instance generate a user controlled horn or whistle as follows:

Import the swelling start of the whistle into the first part of the sound slot, a middle part of the whistle in loop mode into the second part and the fading whistle into the last part.

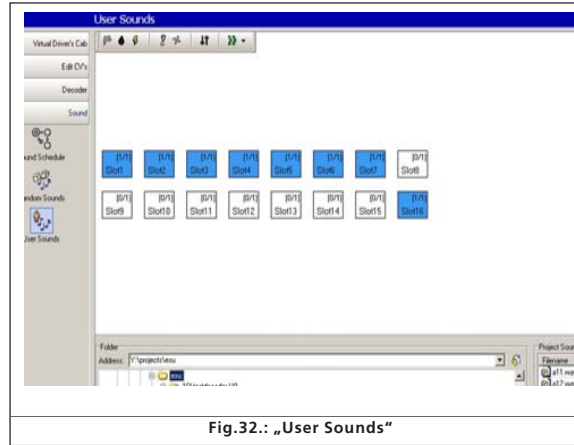

Fig.32.: „User Sounds“



Select „1“ for the number of repetitions for start and end and loop mode for the middle part.

As is the case with random sounds you may select extended sound settings (also refer to 9.5.).

The normal priority of user sounds is 3 or 4.

User Sounds can also be combined with function outputs. Let's assume you link a digital coupler wired to AUX 1 with the sound of the coupler clank. Then the coupler will be activated while the sound is played and afterwards the coupler is deactivated.

9.6.2. Special options for slots 14, 15 and 16

The sound slots 14, 15 and 16 may have special importance under certain circumstances. As described in 9.2.4. slot 14 can be used for automatic shift sounds, slot 15 for automatically triggered sounds immediately after the locomotive has stopped (e.g.: air pump for steam locomotives) and slot 16 for the automatic play of the brake squeal during braking.



To facilitate this, import the suitable shift sound into slot 14 and set slot 14 as automatic sound in the menu of the ... button. Provided you have set rev-modulation (CV 59 and 60, also refer to 8.5.4.) and a certain „Time between Throttle Notches“ in „Sound Settings“ within the „Decoder“ register (CV 57 and 58, also refer to 8.5.1.), then you hear not only the sound of the gear shift but also the changing revs during the transition from one throttle notch to the next. It is recommended to set the priority for the gear shift rather high (14 or 15) to assure that it is definitely played. There is an example in chapter 12.4..

Slot 15: Import the suitable sound that should be played immediately after the locomotive has stopped (e.g.: air pump or parking brake). If you use a sound that should be repeated, only enter a limited number of repetitions. Otherwise the sound would only stop once you disconnect power from this locomotive. Set this sound as „Stop Sound“ with the button ... in the menu of Slot 15.



It is recommended to set the priority for the gear shift rather high (14 or 15) to assure that it is definitely played. There are examples in chapters 12.2. and 12.5..

Slot 16: Import the swelling start of the break squeal into the first part, a sound loop in to the middle square and the fading sound of the brakes in to the third part. Select „Play Sound in a Loop“ for the middle part. Set the priority to high (14 or 15) to assure that it is definitely played.

The brake sound will be played until the locomotive has stopped. You will find an example in 12.2. to 12.5..

9.7. Alternative sounds

In the windows „Sound Settings“ of the sound slots there is an option called „Display Alternative Sounds“. Here you can add additional random or user sounds that run „parallel“ to the normal sounds. The alternative sounds will be played after you pressed the „Shift“ function (also refer to 8.6.8.).

As a standard the „normal“ sounds will be displayed in a sound slot. If you have also imported alternative sounds into a sound slot then the latter will be displayed in yellow.

It is possible to import driving sounds into the sound slots that are played in certain situations only. Thus the LokSound decoder can simulate driving with open cylinder cocks (also refer to 3.1.1.). If you stop a locomotive and immediately afterwards you start it again or if the locomotive is running for a while already, then you will not hear the cylinder cocks anymore, just like with the prototype. Only once the locomotive has been stopped for a while and then starts moving again, will you hear the open cylinder cocks.

How to adjust this is explained in chapter 12.2..

Special Configurations for M4

10. Special configurations for M4

M4 offers several possible settings that are different to DCC as described above. Since the methodology is only slightly different to DCC we only provide an overview.

Please note: Value ranges in M4 are generally different to those in DCC. Therefore the CV numbers for DCC as stated in the previous chapters are not valid for M4.

Please find the correct numbers and values of our sounds for later conversion of non-sound locomotives at www.esu.eu.

10.1. „M4 Settings“ in the „Decoder“

Locomotive symbol: Select a symbol matching your type of locomotive. During operations it will be displayed on your mfx® central unit.

Decoder name: Enter the name of the locomotive (e.g.: „class 50“ or „ICE“). Entries with a maximum of 16 characters are permitted. This name will also be displayed on your mfx® central unit.

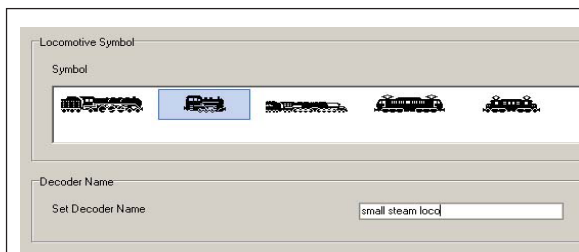

Fig.33.: Loco symbols and decoder names

Function symbols FL up to F15: Allocate symbols on your mfx® central unit to the appropriate functions (e.g.: bell, whistle, pantograph, etc.) for better orientation and identification.

Under „Momentary Action“ you can select the operating mode of the function button. If this option has not been selected, the sound will be played when you press the button and will remain on until you press the button again.

If you have selected this option, then the sound will be played as long as you press the button.

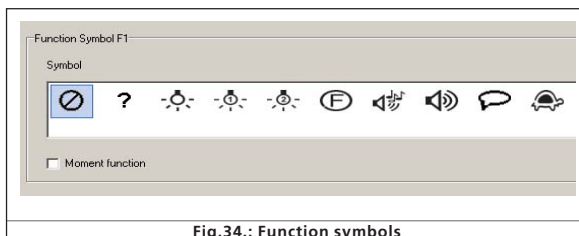

Fig.34.: Function symbols

10.2. Driving characteristics

In M4 mode you do not have to set the number of speed steps since they are almost always 128. Therefore this window does not display a choice list for speed steps.

In M4 mode you can only activate the Märklin® brake mode.

10.3. Motor

M4 uses only one speed curve but not the three-point-characteristic.

Minimum and maximum speed is displayed in this window.

10.4. Motorola® settings

You can set the two Motorola® addresses and also the functions that should be activated automatically in Motorola® mode. To activate this, click into the square of the appropriate function.

10.5. Analogue settings

Here you can set the analogue parameters that are supported by the M4 decoder. They are the same as for DCC decoders.

10.6. Sound settings

As with DCC the following parameters can be adjusted: „Type of Sound“, „Speed of Driving sound“, „Random Sounds“, „Braking Sound Threshold“ and „Overall Volume“. You will find explanations for each of the above in 8.5.

10.7. Function outputs

The function allocation enables you to set sounds, head lights front and back, AUX1 to AUX4, acceleration / deceleration on / off, shunting speed, alternative sounds and sound on / off. The output configuration as well as the blinking frequency of the stroboscopic effect can be adjusted here (also refer to 8.6.).

10.8. Special options

Refer to 10.8.

10.9. Sound

Editing of sounds and of the schedule is exactly the same for M4 as with other decoder types. Only the volume has to be set individually for each sound slot. There are also group volume controllers as with DCC.

11. Special settings for Loksound micro and XL

The LokSound micro and the LokSound XL are only slightly different to the LokSound decoders for H0 scale. Almost all options and parameters are identical; editing sound works exactly the same way.

This section provides a short overview.

11.1. Special settings for Loksound micro

- In the view Driving Characteristics it is really possible to select the „Trix braking mode“.
- In analogue mode LokSound micro can only be operated with DC; AC operation is not permitted.
- There are two more possible settings in special options: „Switch off Load Compensation in Analogue Mode“; however, load compensation remains active in digital mode provided it is not disabled in CV49, Bit 0.
- „Disable PWM in Analogue Mode“: switches off pulse width modulation in analogue mode.

11.2. Special Settings for LokSound XL

- LokSound XL offers the option „Diesel Notch Up“ and „Diesel Notch Down“ and six AUX outputs for extended control of electric or electromechanical devices of your locomotive.
- Aux 5 and 6 can be used as outputs and inputs.
- Functions can also be triggered via sensors. The columns for the sensors are contained in the function mapping table next to the allocation columns for F15.
- The function „Smoke Generator“ cannot be connected to the AUX outputs.

12. Project examples

12.1. Available sounds

The composition of sound building blocks for LokSound decoders is quite complex. Therefore ESU electronic solutions ulm GmbH & Co KG provides several hundred pre-configured sound files (project files) for you. By now there is an ESU sound for almost every class and specific type of locomotive.

Thanks to the LokSound technology you can write different sound files onto your decoder and test them as long as you like respectively until you find the sound of your personal preference.

Of course you have the opportunity to create your own sound with the LokProgrammer by mixing individual sounds.

The following chapters show the step-by-step creation of sound projects in DCC.

Project for a Steam Locomotive

12.2. Project for a steam locomotive

12.2.1. Create a new file

- Select the option „New...“ in the „File“ menu“
- The window „New Project“ pops up
- Select „LokSound V3.5“
- Determine the size of the flash memory (8 Mbit or 16 Mbit) in the scroll down menu at the lower edge of the window. Please note that the size of the flash memory must match the real size of the decoder memory. For our example please choose 8 MBit.
- Click onto „OK“

12.2.2. Settings

Go through the settings as described in chapter 8. The following values are examples for this project:

Go to address:

- Set the address to „1“ in order to run this locomotive with this number on your layout at a later stage.

Go to speed step selection:

- Choose „28 or 128 speed steps“
- Reverse mode: leave the reverse mode switched off. Otherwise your locomotive would move backwards even though your command station or throttle indicates forward.
- Acceleration: Set the value to „10“. This corresponds with 8.69 seconds that means the locomotive takes 8.69 seconds to reach the maximum speed starting at 0.

The acceleration from on intermediate step to the next is reduced accordingly.

- Deceleration: set the braking time to value „8“. This corresponds with 6.952 seconds that means the locomotive takes 6.952 seconds to stop from maximum speed. The time from one intermediate step to the previous one is accordingly lower.
- Supported brake modes: select all supported brake modes to make sure your locomotive behaves as desired regardless of the command station used.
- Trim: Activate the forward-trim and set the value to „128“. Thus the locomotive travels forward according to the selected maximum speed.
- Activate reverse-trim and set the value to „64“. Thus the locomotive travels backwards at maximum 50% of the selected maximum speed. Some steam locomotives travelled slower in reverse than forward.

If the trim options are not activated then the trim value is 100%.

Change to the window „Motor“:

- Set the DC motor PWM frequency to 30kHz as suitable value for LokSound V3.5
- Load compensation: keep the default values as displayed.

- Speed register: go with the cursor to the point in the middle and drag it down a bit within the diagram. Therefore the speed in the lower speed ranges will be somewhat reduced while it increases in the upper range. Particularly diesel shunters and some steam locomotives showed this kind of characteristics.

Change to the window „DCC / Analogue“:

- Leave the Zimo manual function switched off
- Leave all analogue modes active that are already activated
- Set the start voltage for DC to the value „20“; that corresponds to about 4 Volts
- Set the maximum speed for DC to the value „60“; that corresponds to about 12 Volts
- Set the start voltage for AC to the value „30“; that corresponds to 6 Volts
- Set the maximum speed for AC to the value „80“; that corresponds to 16 Volts. The values given here serve as a guide for H0 and XL decoders only. They can be used as starting points for fine tuning your locomotive.
- Activate the outputs FL(f), FL(r) and F1 for the analogue mode. F1 shall be allocated to sound on / off later on.

Change to the window „Sound Settings“:

- Select „Steam Locomotive without External Wheel Sensor“. The synchronization (CV 57 and 58) will be set later (also refer to 12.2.5.)
- Random Sounds: set the values „15“ for minimum time between them and „35“ for maximum time between them. Random sounds will now be played with a time interval of at least 15 and maximum 35 seconds.
- Speed of driving sound: set the minimum value to „32“; that corresponds to 100%. Set the maximum value to „40“; that corresponds to 125%. At maximum speed of the locomotive the speed of the driving sound will be increased by a quarter of the frequency. The transition between the normal and the transposed sounds is subject to the speed and will take place as a soft transition in this case.
- Sound volume: at first leave all controllers on the default value „64“ (maximum).
- Leave also all other parameters in this window on the default values. The fine tuning comes later (also refer to 12.2.6).
- Skip the window „Functions“. It is recommended to do the function mapping only after completing the sound project.
- Change to the window „Special Options“:
- Select all options. In case of a power interruption all activated buttons and set speed values including direction of travel will remain the same.

12.2.3. Import and place sounds

Please use the project file for the class 64 (52403) which you can download from the ESU website at www.loksound.de.

- Change to the „Sound“ register and select „Schedule“
- Open the file „Class 64“ in the window „Folder“ where you have saved it.
- Drag the sound files with the mouse from the window „Folder“ into the window „Project Sounds“. You can observe any changes in the memory at the lower edge of the window.
- Please use the following driving sounds for our example: a11s to a24a, d11s to d24a, da11s to da24a, siedens, siedena, dsa, sda and sd1, as well as cx1 to cx4.
- Import the following sound in the same manner for random sounds and user sounds: all „whistle“-wav-files (init, loop, exit), all bell-wav-files, all injector, air pump and coal shovelling-wav-files.
- Also import the files „brakes_init.wav“, „brakes_loop.wav“ and „brakes_exit.wav“ in the same manner.

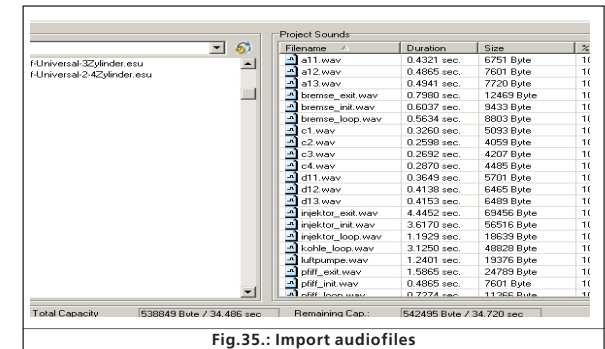

Fig.35.: Import audiofiles

- Click now onto the square marked „S“ and insert „siedens.wav“ in each middle square of the two sound slots
- Click onto „D1“ and import „d11s.wav“ in the head end of the first sound slot.
- Import „siedens.wav“. in the middle part of the first sound slot. Repeat this procedure with „d12s.wav“ and „siedens.wav“ in the second slot and so forth until finally „D1“ looks the same as shown in Fig. 35.
- Then click onto „Display Alternative Sounds“ and import „d11a.wav“ to „d14a.wav“ as well as „siedena.wav“ in the same manner as before.
- Open „Sound Settings“ of the individual audio files (also refer to chapter 9.4).
- Enter the value „1“ for all „d-sounds“ in „Repeat Sound“ in order to play each exhaust chuff once per turn of the driver.

Import and insert sounds



- Select „Loop Mode“ for all boiler sounds; thus the sound is played until the next exhaust chuff no matter how long it takes. There is one exception, namely „sieden.wav“, which you have to import in the upper part of „S“.
- Allocate all sounds to group controller 3 (AUX); thus the driving sounds are all controlled by group controller 3 and can be adjusted as one (also refer to 8.5.6.).
- Click onto „Adapt Sound to Driving Noise“. This causes the driving sounds to increase in pitch with increasing speed.

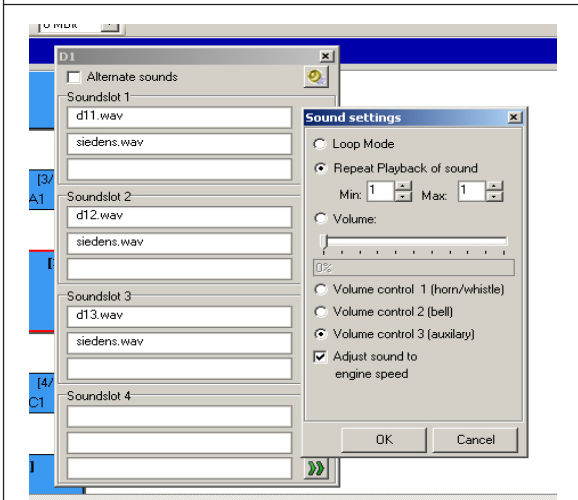
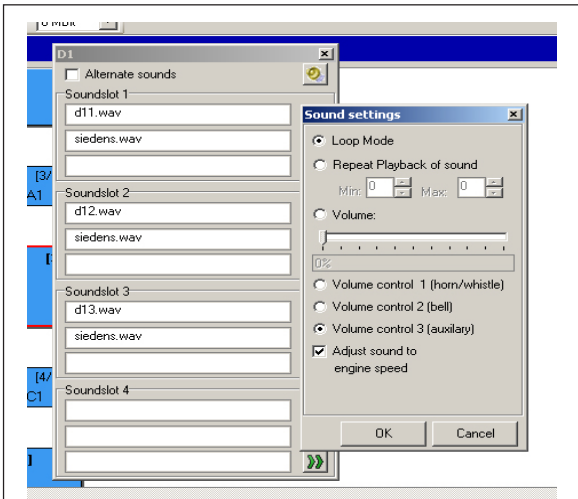

Fig.36.: Extended Sound Settings (D11s.wav & siedens.wav) for a Steamer Project

Change to the window „Random Sounds“:

- Open the square „Stand1“ by double clicking it
 - Import „kohle_init.wav“ in the upper square of the open sound slot
 - Import „kohle_loop.wav“ in the middle square of the open sound slot
 - Click onto the button „Sound Settings“ next to the middle square and enter the value „2“ at „Min.“ in „Repeat Sound“ and „4“ at „Max.“. This causes the loop part of coal shovelling to be repeated several times; thus the duration of shovelling coal varies arbitrarily.
 - Import „kohle_exit.wav“ in the lower square of the open sound slot
 - Repeat this procedure with the square marked „Fahrt1“
- Change to the window „User Sounds“:
- Open the square „Slot1“ by double clicking it
 - Import „pfiff_init.wav“ in the upper square of the open sound slot
 - Import „pfiff_loop.wav“ in the middle square of the open sound slot
 - Click on the button „Sound Settings“ next to the middle square and select the option „Loop Mode“. This causes the loop part of the whistle to play until the user releases the function.
 - Import „pfiff_exit.wav“ in the lower square of the open sound slot
 - Repeat this procedure with the bell in the square „Slot2“, the injector in „Slot3“ and the air pump in „Slot 4“.
 - Allocate the whistle to the volume controller 1 (=CV121) in the window „Sound Settings“ and the bell to volume controller 2 (=CV122). Thus the volume of these important sounds can later be adjusted from your command station (also refer to 8.5.6.).
 - Deal with slot 16 in the same manner by importing the brake sound-wav-files
 - Select the option „Sound Requires Driving sounds“ for all brake sound files in the window „Sound Settings“.



- Click onto the button „Display Extended Settings“ and enter the highest value 15 at „Priority“. This assures that in case of exceeding a certain speed and rapid braking the brake sounds will definitely be played and not suppressed by some other sound.
- Deal with slot 15 with the air pump-wav-files in the same manner. Click onto the button „Sound Settings“ next to the middle square and enter the values 4 at „min.“ and 6 at „Max.“. This causes the decoder to play the loop part of the air pump in slot 15 between four and six times. Ultimately the duration of air pump action varies after the locomotive has come to a complete stop.
- Select the option „Sound Requires Driving Noise“ in the window „Sound Settings“ for all sound files in slot 15.
- Click onto the button „Display Extended Settings“ and enter the highest value 15 at „Priority“. Confirm with OK.
- Go to the button „more settings“ at the top left corner of the screen.



- Select the options „Stop sound“ (user sound slot 15) and „Brake Sound“ (user sound slot 16). Thus the user sound slots 15 and 16 are defined as automatic sounds. The brake sound is automatically played during braking action and the air pump after braking has finished.

12.2.4. Function mapping

Allocate your functions to any buttons as desired (also refer to 8.6.) by clicking the appropriate squares in the corresponding lines respectively columns. The default allocations are as follows:

- Headlights on FL(f), back-up lights on FL(r). Please make sure that the output configuration of the lights is set to „Dimmer“ and the dimmer setting is „15“.
- Driving sounds („Sound on / off“) on F1(f) and F1 (r)
- Horn / whistle on F2 (f) and F2 (r) (e.g.: on user sound slot 1). Set the Doppler effect for a whistle in loop mode; then you can activate it as described in 13.1..
- Shunting speed on F6 (f) and F6 (r). It is recommended to switch off acceleration and deceleration with the same function button in order to assure a faster response in shunting mode.
- Allocate sounds as desired to the other function buttons; you have to import these sounds in user sound slots (also refer to 12.2.3.), e.g.: bell on F3, injector on F4, air pump on F5.

According to the default values the allocations would be as follows:

Illustration on the following page.

Set the Wheel Synchronicity of Exhaust Chuffs

Functions																	
Function Outputs																	
[CV 129 - CV 236]	FS (f)	FS (r)	FF (f)	FF (r)	FL (f)	FL (r)	F1 (f)	F1 (r)	F2 (f)	F2 (r)	F3 (f)	F3 (r)	F4 (f)	F4 (r)	F5 (f)	F5 (r)	F6 (f)
Front Light	<input type="checkbox"/>	<input type="checkbox"/>	<input type="checkbox"/>	<input type="checkbox"/>	<input checked="" type="checkbox"/>	<input type="checkbox"/>	<input type="checkbox"/>	<input type="checkbox"/>	<input type="checkbox"/>	<input type="checkbox"/>	<input type="checkbox"/>	<input type="checkbox"/>	<input type="checkbox"/>	<input type="checkbox"/>	<input type="checkbox"/>	<input type="checkbox"/>	<input type="checkbox"/>
Rear Light	<input type="checkbox"/>	<input type="checkbox"/>	<input type="checkbox"/>	<input type="checkbox"/>	<input type="checkbox"/>	<input checked="" type="checkbox"/>	<input type="checkbox"/>	<input type="checkbox"/>	<input type="checkbox"/>	<input type="checkbox"/>	<input type="checkbox"/>	<input type="checkbox"/>	<input type="checkbox"/>	<input type="checkbox"/>	<input type="checkbox"/>	<input type="checkbox"/>	<input type="checkbox"/>
AUX1	<input type="checkbox"/>	<input type="checkbox"/>	<input type="checkbox"/>	<input type="checkbox"/>	<input type="checkbox"/>	<input type="checkbox"/>	<input type="checkbox"/>	<input type="checkbox"/>	<input type="checkbox"/>	<input type="checkbox"/>	<input type="checkbox"/>	<input type="checkbox"/>	<input type="checkbox"/>	<input type="checkbox"/>	<input type="checkbox"/>	<input type="checkbox"/>	<input type="checkbox"/>
AUX2	<input type="checkbox"/>	<input type="checkbox"/>	<input type="checkbox"/>	<input type="checkbox"/>	<input type="checkbox"/>	<input type="checkbox"/>	<input type="checkbox"/>	<input type="checkbox"/>	<input type="checkbox"/>	<input type="checkbox"/>	<input type="checkbox"/>	<input type="checkbox"/>	<input type="checkbox"/>	<input type="checkbox"/>	<input type="checkbox"/>	<input type="checkbox"/>	<input type="checkbox"/>
[AUX3]	<input type="checkbox"/>	<input type="checkbox"/>	<input type="checkbox"/>	<input type="checkbox"/>	<input type="checkbox"/>	<input type="checkbox"/>	<input type="checkbox"/>	<input type="checkbox"/>	<input type="checkbox"/>	<input type="checkbox"/>	<input type="checkbox"/>	<input type="checkbox"/>	<input type="checkbox"/>	<input type="checkbox"/>	<input type="checkbox"/>	<input type="checkbox"/>	<input type="checkbox"/>
[AUX4]	<input type="checkbox"/>	<input type="checkbox"/>	<input type="checkbox"/>	<input type="checkbox"/>	<input type="checkbox"/>	<input type="checkbox"/>	<input type="checkbox"/>	<input type="checkbox"/>	<input type="checkbox"/>	<input type="checkbox"/>	<input type="checkbox"/>	<input type="checkbox"/>	<input type="checkbox"/>	<input type="checkbox"/>	<input type="checkbox"/>	<input type="checkbox"/>	<input type="checkbox"/>
Diesel notching up	<input type="checkbox"/>	<input type="checkbox"/>	<input type="checkbox"/>	<input type="checkbox"/>	<input type="checkbox"/>	<input type="checkbox"/>	<input type="checkbox"/>	<input type="checkbox"/>	<input type="checkbox"/>	<input type="checkbox"/>	<input type="checkbox"/>	<input type="checkbox"/>	<input type="checkbox"/>	<input type="checkbox"/>	<input type="checkbox"/>	<input type="checkbox"/>	<input type="checkbox"/>
Diesel notching down	<input type="checkbox"/>	<input type="checkbox"/>	<input type="checkbox"/>	<input type="checkbox"/>	<input type="checkbox"/>	<input type="checkbox"/>	<input type="checkbox"/>	<input type="checkbox"/>	<input type="checkbox"/>	<input type="checkbox"/>	<input type="checkbox"/>	<input type="checkbox"/>	<input type="checkbox"/>	<input type="checkbox"/>	<input type="checkbox"/>	<input type="checkbox"/>	<input type="checkbox"/>
Acceleration/Brake Time	<input type="checkbox"/>	<input type="checkbox"/>	<input type="checkbox"/>	<input type="checkbox"/>	<input type="checkbox"/>	<input type="checkbox"/>	<input type="checkbox"/>	<input type="checkbox"/>	<input type="checkbox"/>	<input type="checkbox"/>	<input type="checkbox"/>	<input type="checkbox"/>	<input type="checkbox"/>	<input type="checkbox"/>	<input type="checkbox"/>	<input type="checkbox"/>	<input checked="" type="checkbox"/>
Shunting Mode/Shunting Speed	<input type="checkbox"/>	<input type="checkbox"/>	<input type="checkbox"/>	<input type="checkbox"/>	<input type="checkbox"/>	<input type="checkbox"/>	<input type="checkbox"/>	<input checked="" type="checkbox"/>	<input checked="" type="checkbox"/>	<input type="checkbox"/>	<input type="checkbox"/>	<input type="checkbox"/>	<input type="checkbox"/>	<input type="checkbox"/>	<input type="checkbox"/>	<input type="checkbox"/>	<input checked="" type="checkbox"/>
Sound on/off	<input type="checkbox"/>	<input type="checkbox"/>	<input type="checkbox"/>	<input type="checkbox"/>	<input type="checkbox"/>	<input type="checkbox"/>	<input checked="" type="checkbox"/>	<input checked="" type="checkbox"/>	<input type="checkbox"/>	<input type="checkbox"/>	<input type="checkbox"/>	<input type="checkbox"/>	<input type="checkbox"/>	<input type="checkbox"/>	<input type="checkbox"/>	<input type="checkbox"/>	<input type="checkbox"/>
Shift Mode	<input type="checkbox"/>	<input type="checkbox"/>	<input type="checkbox"/>	<input type="checkbox"/>	<input type="checkbox"/>	<input type="checkbox"/>	<input type="checkbox"/>	<input type="checkbox"/>	<input type="checkbox"/>	<input type="checkbox"/>	<input type="checkbox"/>	<input type="checkbox"/>	<input type="checkbox"/>	<input type="checkbox"/>	<input type="checkbox"/>	<input type="checkbox"/>	<input type="checkbox"/>
Fan Sound	<input type="checkbox"/>	<input type="checkbox"/>	<input type="checkbox"/>	<input type="checkbox"/>	<input type="checkbox"/>	<input type="checkbox"/>	<input type="checkbox"/>	<input type="checkbox"/>	<input type="checkbox"/>	<input type="checkbox"/>	<input type="checkbox"/>	<input type="checkbox"/>	<input type="checkbox"/>	<input type="checkbox"/>	<input type="checkbox"/>	<input type="checkbox"/>	<input type="checkbox"/>
Doppler	<input type="checkbox"/>	<input type="checkbox"/>	<input type="checkbox"/>	<input type="checkbox"/>	<input type="checkbox"/>	<input type="checkbox"/>	<input type="checkbox"/>	<input type="checkbox"/>	<input type="checkbox"/>	<input type="checkbox"/>	<input type="checkbox"/>	<input type="checkbox"/>	<input type="checkbox"/>	<input type="checkbox"/>	<input type="checkbox"/>	<input type="checkbox"/>	<input type="checkbox"/>
Volume Control / Mute	<input type="checkbox"/>	<input type="checkbox"/>	<input type="checkbox"/>	<input type="checkbox"/>	<input type="checkbox"/>	<input type="checkbox"/>	<input type="checkbox"/>	<input type="checkbox"/>	<input type="checkbox"/>	<input type="checkbox"/>	<input type="checkbox"/>	<input type="checkbox"/>	<input type="checkbox"/>	<input type="checkbox"/>	<input type="checkbox"/>	<input type="checkbox"/>	<input type="checkbox"/>
Dynamic Brake	<input type="checkbox"/>	<input type="checkbox"/>	<input type="checkbox"/>	<input type="checkbox"/>	<input type="checkbox"/>	<input type="checkbox"/>	<input type="checkbox"/>	<input type="checkbox"/>	<input type="checkbox"/>	<input type="checkbox"/>	<input type="checkbox"/>	<input type="checkbox"/>	<input type="checkbox"/>	<input type="checkbox"/>	<input type="checkbox"/>	<input type="checkbox"/>	<input type="checkbox"/>
Sound Slots	0	0	0	0	0	0	0	0	1	1	2	2	3	3	4	4	0

Fig.37.: Default Allocation of Function Buttons

12.2.5. Set the wheel synchronicity of exhaust chuffs



After you have imported all sounds into the correct sound slots and have entered the first driving parameters it is time to look at a special feature for steam locomotives without external wheel sensor, namely setting the exhaust chuffs according to the revs of the drivers. You can set the necessary parameters with the option „Type of Sound“ 12.2.5. Radsynchronität der Dampfstöße einstellen(CV57 and 58). First make sure that the correct number of cylinders has been entered in the menu „Extended Settings“ and that you have imported the appropriate chuff sounds (also refer to 9.2.4.). Furthermore the mid speed and the maximum speed (CV5 and 6) must have been set since this would influence the synchronicity if it was changed later on.

- Place the locomotive onto the programming track or a test bed.
- Run the locomotive on speed step 1 with the virtual cab or your digital system.
- Observe one wheel and its movement and count the number of exhaust chuffs that are played during one turn of the wheel.

- If there are too many chuffs during one turn the time span is too small. Increase the value in CV 57 until the desired synchronicity is achieved.
- If there are not enough chuffs during one turn the time span is too big. Reduce the value in CV 57 until the desired synchronicity is achieved.
- Now switch to speed step 2.
- Observe one wheel and its movement and count the number exhaust chuffs that are played during one turn of the wheel.
- If there are too many chuffs during one turn the time span is too small. Increase the value in CV 58 until the desired synchronicity is achieved.
- If there are not enough chuffs during one turn the time span is too big. Reduce the value in CV 57 until the desired synchronicity is achieved.

Since CV 57 and 58 influence each other you must check the synchronicity of speed steps 1 and 2 repeatedly. Thus you get closer and closer to the desired synchronicity in several steps.

12.2.6. Fine tuning

Save the project and write it onto your decoder with the aid of your LokProgrammer. Use the buttons ,  and . Listen to the sounds during normal operation and fine tune them further if necessary.

Sound volumes: You can adjust the volume of the individual sound settings in the sound slots separately or with the group volume controllers 1 to 312.2.6. Feinabstimmung.

In our example you can adjust all driving sounds with controller 3 (=CV123), the whistle with controller 1 (=CV121) and the bell with controller 2 (=CV122); all other sounds are adjusted individually.

You can adjust the overall volume in the menu „Sound Settings“ or with CV 63.

Minimal time between chuffs: should the exhaust chuffs sound too hard a high speeds you can set a time limit with the option „Minimal time between exhaust chuffs“. Then the chuffs will not be played any closer together than that time limit. Once the locomotive reaches the speed at which the current time between chuffs corresponds with the minimal time between chuffs the time remains constant – even at higher speeds. This method is recommended for high speeds of the locomotive since the synchronicity cannot be observed anyway.

Brake sound threshold: If the brake sound starts too late or (due to the large file size) it is not played at all simply increase the value for the brake sound threshold. The higher the value, the sooner the brake sound starts playing and therefore has more time to be played completely (also refer to 8.5.5.).



In the following chapters many processes that you already know are repeated from the creation of the steam sound project. Therefore we only describe the settings that are different in the following chapter.

12.3. Diesel-electric locomotive

12.3.1. Generate new file

Proceed as in 12.2.1..

12.3.2. Settings

Proceed as in 12.3.2., but select „Diesel-electric“ as type of locomotive. Enter the value „1“ for „Time between Throttle Notches“. Then the decoder does not divide the sound automatically in to throttle notches; this is done later with the different sound files for different throttle notches.

Also set the following under „Address“: Click onto the squares „FL (f)“ and „FL(r)“ in „Function outputs in consists“. If locomotives are run in consist, then the lights can be controlled in both locomotives simultaneously.

Should there be only one driving sound file (d1.wav) it is recommended to set a higher value for „Time between throttle notches“. This results in the modulation of sound with different pitch levels.

12.3.3. Import and set sounds

Please use the project file for the ALCO 244 (72400) for this example, which you can download from the ESU website at www.esu.eu.

- Change to the „Sound“ register and select „Schedule“.
- Open the file of the ALCO 244 in the window „Folders“.
- Drag the audio files with the mouse from „Folders“ to „Project sounds“. You can observe changes in memory space during this process.
- Please use the following driving sounds for this example: all ms- and sm-sounds, d1.wav to d4.wav, cd1/dc1- to dc/cd4-, d12- to d34- and d43- to d21-, ds-, sd- and s.wav
- Import the following sounds in the same manner for Random Sounds and User Sounds: all „Wabco-A2“-wav-files (init, loop, exit, short), all „bell“-wav-files, all fan-files, „coupler_exit.wav“ and the detector file.
- Also import the files „brake_init.wav“, „brake_loop.wav“ and „brake_exit.wav“ in the same manner.
- Click onto the square called „MS“ and import the files for ms1 into the first square of the upper sound slot, ms2 into the second square.
- Click now onto the square „S“ and import „s.wav“ in the middle squares of the two sound slots.
- Click on to „D1“ and import „d1.wav“ into the middle square of the sound slot (also refer to Fig. 38.).
- Repeat this procedure with all throttle notches up to D4.
- Import d12.wav, d21.wav, d23.wav, cd1.wav, cd2.wav etc. into the respective transition steps.
- Open „Sound Settings“ for the individual audio files (also refer to chapter 9.4.).
- Enter „Loop mode“ for all sounds from D1, D2, D3 and D4, CX. In the square „S“ choose this option only for the second sound slot.
- Enter the value 1 in „Repeat sounds“ for all transition sounds so as to play each transition sound only once until the following throttle notch is reached.
- Allocate all sounds to volume controller 3 („AUX“). Thus the driving sounds will be controlled simultaneously by controller 3.
- Click onto „Adapt sound to Driving Sound“ for each sound. This causes the driving sound to increase in pitch with increasing speed.

Since there are no acceleration files in this example (A1, A2, Da1 etc.) you must enter in the thresholds for each path between the D- and DA-squares the highest possible value of 127. That means that the „barrier“ upwards is so big that the sound sequence always goes via the D-notches and not via the A-notches. To facilitate this, click into the appropriate squares and enter the value 127.

Change to the window „Random Sounds“:

- Open the square „Stand1“ by double clicking it.
- Import „coupler_exit.wav“ in the middle square of the open sound slot; this sound shall simulate the automatic air release later on.
- Repeat this process with the squares called „Fahrt1“

Change to the window „User Sounds“:

- Open the „Slot1“ by double clicking the square
 - Import „wabcoa2_init.wav“ in the upper square of the open sound slot
 - Import „wabcoa2_loop.wav“ in the middle square of the open sound slot
 - Click onto the button „Sound settings“ next to the middle square and select the option „Loop mode“. This cause the whistle to sound until the user deactivates this function.
 - Import „wabcoa2_exit.wav“ in the lower square of the open sound slot
 - Repeat this procedure with the bell in the square „Slot2“, the detector in „Slot3“ and the fan in „Slot 4“.
 - Allocate the whistle to the volume controller 1 (=CV121) and the bell to volume controller 2 (=CV122) in the window „Sound settings“. Thus you can later adjust the volume of these important sounds with your digital system later on.
 - Proceed in the same manner with Slot16 and the braking sound-wav-files.
 - Select for all brake sound files the option „Sound requires Driving Sound“ in the window „Sound Settings“.
 - Click onto the button „Display Extended Settings“ and enter the highest value 15 in „Priority“ in order to assure that the brake sound is not suppressed by any other sound. Confirm with OK.
 - Go to the button „Extended Settings“ at the top left corner of the screen.
- Click the option „Brake Sounds“ (user sound slot 16). Thus the user sound slot 16 is marked as an automatic sound. The brake sound will be played automatically during operation.



12.3.4. Function mapping



Allocate your functions to any buttons as desired (also refer to 8.6.) by clicking the appropriate squares in the corresponding lines respectively columns.

Here we also use the same default allocations:

- Headlights on FL(f), back-up lights on FL(r). Please make sure that the output configuration of the lights is set to „Dimmer“ and the dimmer setting is „15“.
- Driving sounds („Sound on / off“) on F1(f) and F1 (r)
- Horn / whistle on F2 (f) and F2 (r) (e.g.: on user sound slot 1). Set the Doppler Effect for a whistle in loop mode; then you can activate it as described in 13.1..
- Shunting mode on F6 (f) and F6 (r). It is recommended to switch off acceleration and deceleration with the same function button in order to assure a faster response in shunting mode.
- Allocate sounds as desired to the other function buttons; you have to import these sounds in user sound slots (also refer to 12.2.3.), e.g.: bell on F3, injector on F4, air pump on F5.

12.3.5. Fine tuning

Save the project and write it onto your decoder with the aid of your LokProgrammer.

Use the buttons , , and . Listen to the sounds during normal operation and fine tune them further if necessary. Adjust the sound volumes as described in 12.2.6.

If you wish to play a certain driving sound (e.g.: D2) with a certain delay, enter a higher value into the square „barrier“ between the throttle notches and the transition steps (also refer to 9.3.3.). If you wish that a certain throttle notch starts sooner reduce the barrier value on the left by clicking onto the square and entering the new value.

This tuning requires some experience and should definitely be tried out.

Should the coasting sound start too quickly in case of a rapid reduction of speed you can enter a negative value into the thresholds between the D- and DC-notches (e.g.: -10 instead of -5). You can also suppress the transition to coasting completely by entering the lowest possible value, namely -128. .

Should the coasting sound be played for too long reduce the value in the square „Coasting“ at the top edge of the notch CX (9.3.3.).

Diesel-hydraulic/Diesel-mechanical

12.4. Diesel-hydraulic / Diesel-mechanical

12.4.1. Generate new file

Proceed as in 12.2.1..

12.4.2. Settings

Proceed as in 12.4.2. Einstellungen 12.2.2., but select the locomotive type „Diesel locomotive hydraulic“ respectively „Diesel locomotive with manual transmission“.

12.4.3. How to import and set sounds

Please use the project file for the class VT 98 (52454), which you can download from the ESU website at www.esu.eu.

Change to the „Sound“ register and select „Schedule“:

- Open the file of the V 98 in the window „Folders“.
- Drag the audio files with the mouse from „Folders“ to „Project sounds“. You can observe changes in memory space during this process.
- Please use the following driving sounds for this example: all ms.wav und sm.wav, d1.wav, ds-, sd- und s.wav
- Import the following sounds in the same manner for Random Sounds and User Sounds: all „Horn“-wav-files (init, loop, exit, short), all „Conductor“-wav-files and „Compressed air.wav“.
- Also import the files „brake_init.wav“, „brake_loop.wav“ and „brake_exit.wav“ in the same manner.
- Import the sounds to the appropriate throttle notches.
- Now open „Sound Settings“ for the individual audio files (also refer to chapter 9.4.).
- Enter „Loop mode“ for all sounds from D1 and the second part of notch S.
- Enter the value 1 in „Repeat sounds“ for all transition sounds and for s.wav in the first part of notch S so as to play each transition sound only once until the following throttle notch is reached.
- Allocate all sounds to volume controller 3 („AUX“). Thus the driving sounds will be controlled simultaneously by controller 3.
- Click onto „Adapt Sound to Driving Sound“ for each sound. This causes the driving sound to increase in pitch with increasing speed.

Since there are no acceleration files in this example (A1, A2, Da1, DC1, etc.) you must enter in the thresholds for each path between the D- and DA-squares the highest possible value of 127 and towards CX to -127.

Change to the window „User Sounds“:

- Open the „Slot1“ by double clicking the square
- Import „horn_init.wav“ in the upper square of the open sound slot
- Import „horn_loop.wav“ in the middle square of the open sound slot

- Click onto the button „Sound settings“ next to the middle square and select the option „Loop mode“. This causes the horn to sound until the user deactivates this function.
- Import „horn_exit.wav“ in the lower square of the open sound slot
- Repeat this procedure with the conductor's whistle in the square.
- Allocate the horn to the volume controller 1 (=CV121) and the conductor's whistle to volume controller 2 (=CV122) in the window „Sound settings“. Thus you can later adjust the volume of these important sounds with your digital system later on.
- Proceed in the same manner with Slot 16 and the braking sound-wav-files.
- Select for all brake sound files the option „Sound requires Driving Sound“ in the window „Sound settings“.
- Click onto the button „display extended settings“ and enter the highest value 15 in „Priority“ in order to assure that the brake sound is not suppressed by any other sound. Confirm with OK.



- Go to the button „more settings“ at the top left corner of the screen. Select the option „brake sounds“ (user sound slot 16). Thus the user sound slot 16 is marked as an automatic sound. The brake sound will be played automatically during operation.



- Import pressluft.wav in sound slot 14 and set the priority to value 15. Go to the button „more settings“ at the top left corner of the screen. Select the option „Shift sound“ (user sound slot 14). Thus the user sound slot 14 is defined as an automatic sound. The shift sound will be played automatically during operation.

12.4.4. Function mapping

Allocate your functions to any buttons as desired (also refer to 8.6.) by clicking the appropriate squares in the corresponding lines respectively columns.

Here we also use the same default allocations:

- Headlights on FL(f), back-up lights on FL(r). Please make sure that the output configuration of the lights is set to „Dimmer“ and the dimmer setting is „15“.
- Driving sounds („Sound on / off“) on F1(f) and F1 (r)
- Horn on F2 (f) and F2 (r) (e.g.: on user sound slot 1). Set the Doppler effect for a whistle in loop mode; then you can activate it as described in 13.1..
- Shunting speed on F6 (f) and F6 (r). It is recommended to switch off acceleration and deceleration with the same function button in order to assure a faster response in shunting mode.
- Allocate sounds as desired to the other function buttons; you have to import these sounds in user sound slots (also refer to 12.2.3.), e.g.: bell on F3, detector on F4, fan on F5.

12.4.5. Fine tuning

Save the project and write it onto your decoder with the aid of your LokProgrammer.

Use the buttons ,  and .

Listen to the sounds during normal operation and fine tune them further if necessary.

Adjust the sound volumes as described in 12.2.6.

12.5. Electric locomotive

12.5.1. Generate new file

12.5.2. Settings

Proceed as in 12.3.2..

12.5.3. How to import and set sounds

Please use the project file for the Euro Sprinter (524876), which you can download from the ESU website at www.esu.eu.

Change to the „Sound“ register and select „Schedule“:

- Open the file of the Euro Sprinter in the window „Folders“.
- Drag the audio files with the mouse from „Folders“ to „Project sounds“. You can observe changes in memory space during this process.
- Please use the following driving sounds for this example:
 - Pantograph up und Pantograph down
 - Hs_on.wav
 - Mute.wav
 - Sd1-, sd2-, ds- und d1
- Import the following sounds in the same manner for Random Sounds and User Sounds: all „airhorn_1“-wav-files (init, loop, exit, short) and all „fan“-wav-files.
- Also import the files „brake_init.wav“, „brake_loop.wav“ and „brake_exit.wav“ in the same manner.
- Click onto the square „MS“ and import the file „pantograph_up.wav“ into the upper sound slot and hs_on.wav into the second square.
- Now click onto the square „S“ and import the two files „mute.wav“ in the middle squares of the two sound slots.
- Now click onto „D1“ and import the file „d1.wav“ in the middle square of the sound slot (also refer to Fig. 36).
- Now click onto the square „sd“ and import the file „sd1.wav“ in the upper sound slot and „sd2.wav“ in the second square.
- Now click onto the square „ds“ and import the file „ds.wav“.
- Now open the „Sound settings“ of the individual audio files (also refer to chapter 9.4.).
- Enter „Loop mode“ for D1 and the second part of notch „S“.

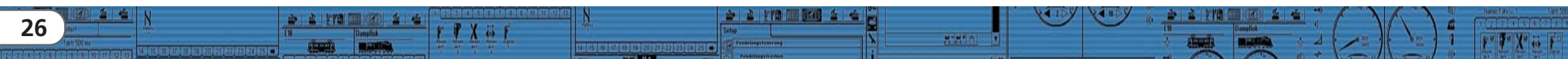

Dieselhydraulic/Dieselmehanical

- Enter the value 1 in „Repeat sounds“ for all transition sounds and for s.wav in the first part of notch S so as to play each transition sound only once until the following throttle notch is reached.
- Allocate all sounds to volume controller 3 („AUX“). Thus the driving sounds will be controlled simultaneously by controller 3.
- Click onto „Adapt sound to Driving Sound“ for each sound. This causes the driving sound to increase in pitch with increasing speed.

Since there are no acceleration files in this example (A1 to Da1) and no coasting files (in CD1, DC1 and CX) you must enter in the thresholds for each path between the D1- and DA1-squares the highest possible value of 127. Furthermore you must set the threshold between D1 and DC1 to -128.

Change to the window „User Sounds“:

- Open the „Slot1“ by double clicking the square
- Import „airhorn1_init.wav“ in the upper square of the open sound slot
- Import „airhorn1_loop.wav“ in the middle square of the open sound slot
- Click onto the button „Sound settings“ next to the middle square and select the option „Loop mode“. This causes the horn to sound until the user deactivates this function.
- Import „airhorn_exit.wav“ in the lower square of the open sound slot
- Allocate the horn to the volume controller 1 (=CV121) in the window „Sound settings“. Thus you can adjust the volume of this important sound with your digital system later on.
- Proceed in the same manner with Slot 16 and the brake sound-wav-files and with Slot 15 with the „fan“ files.
- Select for all brake sound files the option „Sound requires Driving Sound“ in the window „Sound settings“.
- Click onto the button „display extended settings“ and enter the highest value 15 in „Priority“ in order to assure that the brake sound is not suppressed by any other sound. Do the same with slot 15 to assure that the fan sound is not suppressed by any other sound.
- Confirm with OK and go to the button „more settings“ at the top left corner of the screen.
Select the option „brake sounds“ (user sound slot 16). Thus the user sound slot 16 is marked as an automatic sound. The brake sound will be played automatically during operation.
- Also select „Stop Sound“ (user sound slot 15); thus the fan will be heard every time after braking.

12.5.4. Function mapping

Allocate your functions to any buttons as desired (also refer to 8.6.) by clicking the appropriate squares in the corresponding lines respectively columns.

Here we also use the same default allocations:

- Headlights on FL(f), back-up lights on FL(r). Please make sure that the output configuration of the lights is set to „Dimmer“ and the dimmer setting is „15“.

- Driving sounds („Sound on / off“) on F1(f) and F1 (r)
- Horn on F2 (f) and F2 (r) (e.g.: on user sound slot 1). Set the Doppler effect for a whistle in loop mode; then you can activate it as described in 13.1..
- Shunting speed on F6 (f) and F6 (r). It is recommended to switch off acceleration and deceleration with the same function button in order to assure a faster response in shunting mode.

12.5.5. Fine tuning

Save the project and write it onto your decoder with the aid of your LokProgrammer.

Use the buttons ,  and .

Listen to the sounds during normal operation and fine tune them further if necessary.

Adjust the sound volumes as described in 12.2.6.



13. Appendix

13.1. Miscellaneous

13.1.1. Activating the Doppler effect during operation:

- Press the appropriate function button (e.g.: F2 horn) at a speed of more than 50% of the maximum speed.
- Wait for about 3 seconds. Then double click the function button. The pitch will be lowered.
- Deactivate the horn button. A few seconds later the sound will go back to normal.

13.1.2. Hardware of LokSound (cables, colours)

Pin	Description	Color Code
1	motor terminal right	orange
2	rear light	yellow
3	function F1	green
4	track connection left	black
5	motor terminal left	gray
6	headlight	white
7	common (+pole)	blue
8	track connection right	red



Figure1: NEM652 interface

Pin	Description	Color Code
1	motor terminal right	orange
2	motor terminal left	gray
3	track connection right	red
4	track connection left	black
5	head light	white
6	rear light	yellow



Figure1: NEM651 interface

Fig.39.: Wiring of H0-decoder and micro-decoder

13.1.3. Problems when reading the decoder

Should the program not be able to read out decoder data then an error message will be displayed.

The display of that message could have several reasons:

- The locomotive is not set properly on the programming track or the track is not properly connected to the LokProgrammer.
- The decoder is not wired correctly – particularly the motor leads - in the locomotive.
- The decoder may be faulty.
- The track is dirty.



We recommend highly checking the FAQs on our website at www.esu.eu.

You can reach us by several means. However, we kindly request you to contact us by fax or email first. We will reply within a short period of time. Please always state your own fax number or email address.

Our telephone hotline can be pretty busy. Therefore you should only call if the other options do not seem practical. Also check our website, you will find many useful hints and answers to questions already raised by others under Tips & Tricks.

13.1.4. Memory types 8MBits and 16MBits

Generation 3 LokSound-decoders provide different memory sizes: 8MBits (for about 69 seconds of sound data) and 16MBits (for about 138 seconds of sound data). The ESU-retailmarket sounds on our Website are mostly made for 8MBits memory, so that owners of older Loksound 3 sound decoders can use them. But OEM-LokSound-Projects could be bigger than 8MBits.

It is always possible to transfer 8MBit-files onto a 16MBits-decoder zu übertragen. You can't transfer a 16MBits-file onto an 8MBits decoder because of the memory discrepancies.

Please do the following procedure to change an 8MBits Sound-file to a 16MBits file:

- load the requested ESU-file
- upload the 8MBits ESU-file onto a 16MBits-decoder (see also 5.3.)
- Read out the decoder date by using the intended button , while the file is still loaded (see also 5.3.)
- Confirm that the decoder data should be adopted to the open project file.

16MBits memory size is now shown on the information display in the upper center of the screen.

The memory capacity in the menu „Sound“ is now 16MBits (which equals about 138 seconds). This memory is now available for your projects.

- Save the file. The 16MBits characteristics will be saved now.

Hotline: +49 (0) 700 - 56576863 *)
(0)700 - LOKSOUND
Tuesday and Wednesday
10:00 am - 12:00 pm

Fax: +49 (0) 700- 37872538 *)

Online: www.esu.eu/en/support

Post: ESU electronic solutions ulm GmbH & Co. KG
-Technical Support-
Industriestrasse 5
D - 89081 Ulm

www.esu.eu

*) 0.12Euro per minute

CV Overview Chart

13.3. CV overview chart

CV Name	Description	Range	Def.																											
1 Engine address	Address of engine	1 – 127	3																											
2 Start voltage	Sets the minimum speed of the engine	1 – 75	3																											
3 Acceleration	This value multiplied by 0.869 is the time from stop to maximum speed	0 – 64	8																											
4 Deceleration	This value multiplied by 0.869 is the time from maximum speed to stop	0 – 64	6																											
5 Maximum speed	Maximum speed of engine	0 – 64	64																											
6 Medium speed	Medium speed of engine	0 – 64	22																											
7 Version number	Internal software version of LokSound decoder																													
8 Manufacturer's ID	Manufacturer's ID & reset to factory defaults by writing value 8 in this CV	151																												
13 Analogue mode F1-F8	Status of functions F1 to F8 in analogue mode	0-255	1																											
	<table border="1"> <thead> <tr> <th>Bit</th> <th>Description</th> <th>Value</th> </tr> </thead> <tbody> <tr> <td>0</td> <td>F1</td> <td>1</td> </tr> <tr> <td>1</td> <td>F2</td> <td>2</td> </tr> <tr> <td>2</td> <td>F3</td> <td>4</td> </tr> <tr> <td>3</td> <td>F4</td> <td>8</td> </tr> <tr> <td>4</td> <td>F5</td> <td>16</td> </tr> <tr> <td>5</td> <td>F6</td> <td>32</td> </tr> <tr> <td>6</td> <td>F7</td> <td>64</td> </tr> <tr> <td>7</td> <td>F8</td> <td>128</td> </tr> </tbody> </table>	Bit	Description	Value	0	F1	1	1	F2	2	2	F3	4	3	F4	8	4	F5	16	5	F6	32	6	F7	64	7	F8	128		
Bit	Description	Value																												
0	F1	1																												
1	F2	2																												
2	F3	4																												
3	F4	8																												
4	F5	16																												
5	F6	32																												
6	F7	64																												
7	F8	128																												
14 Analogue mode FL, F9-F12	Status of functions FL, F9 to F12 in analogue mode	0-255	3																											
	<table border="1"> <thead> <tr> <th>Bit</th> <th>Description</th> <th>Value</th> </tr> </thead> <tbody> <tr> <td>0</td> <td>FL (f)</td> <td>1</td> </tr> <tr> <td>1</td> <td>FL (r)</td> <td>2</td> </tr> <tr> <td>2</td> <td>F9 (f)</td> <td>4</td> </tr> <tr> <td>3</td> <td>F10 (f)</td> <td>8</td> </tr> <tr> <td>4</td> <td>F11</td> <td>16</td> </tr> <tr> <td>5</td> <td>F12</td> <td>32</td> </tr> <tr> <td>6</td> <td>F9 (r)</td> <td>64</td> </tr> <tr> <td>7</td> <td>F10 (r)</td> <td>128</td> </tr> </tbody> </table>	Bit	Description	Value	0	FL (f)	1	1	FL (r)	2	2	F9 (f)	4	3	F10 (f)	8	4	F11	16	5	F12	32	6	F9 (r)	64	7	F10 (r)	128		
Bit	Description	Value																												
0	FL (f)	1																												
1	FL (r)	2																												
2	F9 (f)	4																												
3	F10 (f)	8																												
4	F11	16																												
5	F12	32																												
6	F9 (r)	64																												
7	F10 (r)	128																												
17 Extended engine address	Long address of engine; CV17 contains byte with higher value (bit 6 and 9999, bit 6 and bit 7 must always be active), CV18 contains byte with lower value (only active when function is switched on in CV 29).	0-128																												
19 Consist address (additional in case of double traction)	Value 0 or 128 means: consist address deactivated 1 - 127 consist address, normal direction 129-255 consist address, reverse direction	0 – 255																												

CV Name	Description	Range	Def.																											
29 Configuration register	<table border="1"> <thead> <tr> <th>Bit</th> <th>Function</th> <th>value</th> </tr> </thead> <tbody> <tr> <td>0</td> <td>Reverse travel direction (forward becomes reverse) normal direction reversed direction</td> <td>0 1</td> </tr> <tr> <td>1</td> <td>speed steps (only for DCC mode) 14 speed steps 28 or 128 speed steps</td> <td>0 2</td> </tr> <tr> <td>2</td> <td>analogue operation analogue operation off analogue operation on</td> <td>0 4</td> </tr> <tr> <td>4</td> <td>selection of speed curve speed curve through CV 2,5, 6 speed curve through CV 67 – 96</td> <td>0 16</td> </tr> <tr> <td>5</td> <td>selection of engine address (only for DCC) short addresses (CV 1) in DCC mode long addresses (CV 17 + 18) in DCC mode</td> <td>0 32</td> </tr> </tbody> </table>	Bit	Function	value	0	Reverse travel direction (forward becomes reverse) normal direction reversed direction	0 1	1	speed steps (only for DCC mode) 14 speed steps 28 or 128 speed steps	0 2	2	analogue operation analogue operation off analogue operation on	0 4	4	selection of speed curve speed curve through CV 2,5, 6 speed curve through CV 67 – 96	0 16	5	selection of engine address (only for DCC) short addresses (CV 1) in DCC mode long addresses (CV 17 + 18) in DCC mode	0 32	0 - 55	4									
Bit	Function	value																												
0	Reverse travel direction (forward becomes reverse) normal direction reversed direction	0 1																												
1	speed steps (only for DCC mode) 14 speed steps 28 or 128 speed steps	0 2																												
2	analogue operation analogue operation off analogue operation on	0 4																												
4	selection of speed curve speed curve through CV 2,5, 6 speed curve through CV 67 – 96	0 16																												
5	selection of engine address (only for DCC) short addresses (CV 1) in DCC mode long addresses (CV 17 + 18) in DCC mode	0 32																												
49 Extended configuration	<p>Activate support for brake sections or switch off Back EMF control</p> <table border="1"> <thead> <tr> <th>Bit</th> <th>description</th> <th>value</th> </tr> </thead> <tbody> <tr> <td>0</td> <td>load control off load control activated in</td> <td>0 1</td> </tr> <tr> <td>1</td> <td>DC motor PWM frequency 15 kHz pulse frequency 30 kHz pulse frequency</td> <td>0 2</td> </tr> <tr> <td>2</td> <td>Märklin® delta mode Delta mode off Delta mode on</td> <td>0 4</td> </tr> <tr> <td>3</td> <td>Märklin® second address second address off second address on</td> <td>0 8</td> </tr> <tr> <td>4</td> <td>Automatic speed step detection DCC speed step detection off DCC speed step detection on</td> <td>0 16</td> </tr> <tr> <td>5</td> <td>LGB function button mode LGB mode off LGB mode on</td> <td>0 32</td> </tr> <tr> <td>6</td> <td>Zimo manual function Zimo manual function off Zimo manual function on</td> <td>0 64</td> </tr> <tr> <td>7</td> <td>Loksound 2 behaviour on LokSound 2 behaviour off</td> <td>0 128</td> </tr> </tbody> </table>	Bit	description	value	0	load control off load control activated in	0 1	1	DC motor PWM frequency 15 kHz pulse frequency 30 kHz pulse frequency	0 2	2	Märklin® delta mode Delta mode off Delta mode on	0 4	3	Märklin® second address second address off second address on	0 8	4	Automatic speed step detection DCC speed step detection off DCC speed step detection on	0 16	5	LGB function button mode LGB mode off LGB mode on	0 32	6	Zimo manual function Zimo manual function off Zimo manual function on	0 64	7	Loksound 2 behaviour on LokSound 2 behaviour off	0 128	0-128	19
Bit	description	value																												
0	load control off load control activated in	0 1																												
1	DC motor PWM frequency 15 kHz pulse frequency 30 kHz pulse frequency	0 2																												
2	Märklin® delta mode Delta mode off Delta mode on	0 4																												
3	Märklin® second address second address off second address on	0 8																												
4	Automatic speed step detection DCC speed step detection off DCC speed step detection on	0 16																												
5	LGB function button mode LGB mode off LGB mode on	0 32																												
6	Zimo manual function Zimo manual function off Zimo manual function on	0 64																												
7	Loksound 2 behaviour on LokSound 2 behaviour off	0 128																												
50 Analogue mode	<p>Selection of desired analogue mode</p> <table border="1"> <thead> <tr> <th>Bit</th> <th>description</th> <th>value</th> </tr> </thead> <tbody> <tr> <td>0</td> <td>AC analogue mode AC analogue mode off AC analogue mode on</td> <td>1</td> </tr> <tr> <td>1</td> <td>DC analogue mode DC analogue mode off DC analogue mode on</td> <td>2</td> </tr> </tbody> </table>	Bit	description	value	0	AC analogue mode AC analogue mode off AC analogue mode on	1	1	DC analogue mode DC analogue mode off DC analogue mode on	2	0-3	3																		
Bit	description	value																												
0	AC analogue mode AC analogue mode off AC analogue mode on	1																												
1	DC analogue mode DC analogue mode off DC analogue mode on	2																												

CV Overview Chart

CV Name	Description	Range	Def.	CV Name	Description	Range	Def.			
51 Brake mode	Selection of desired brake mode		0-16	3	67 Speed table	Defines motor voltage for speed steps. Intermediate values will be interpolated.		0-255	--	
	Bit	description				value				
	0	Märklin® brake mode Märklin® brake mode off Märklin® brake mode on				0 1				
	1	Zimo brake mode Zimo brake mode off Zimo brake mode on				0 2				
	3	Lenz DC brake mode Lenz brake mode off Lenz brake mode on				0 8				
4	Trix brake mode Trix brake mode off Trix brake mode on	0 16								
53 Control reference	Defines the Back EMF voltage, which the motor should generate at maximum speed. The higher the efficiency of the motor, the higher this value may be set. If the engine does not reach maximum speed, reduce this parameter.	0-80	56	95 Reverse trim	Divided by 128 is the factor used to multiply the motor voltage when driving backwards. Value 0 deactivates the trim.	0-255	0			
54 Load control parameter K	K-component of internal PI-controller Defines the effect of load control. The higher the value, the stronger the effect of Back EMF control	0-80	32	112 Blinking light	Blinking frequency of Strobe effects. Always a multiple of 65.536 milliseconds.	4-64	33			
55 Load control parameter I	„I“-component of internal PI-controller, defines momentum inertia) of motor. The higher the momentum of the motor (large flywheel or bigger diameter motor) the lower this value has to be set (see Chapter X.X.)	0-80	24	113 Headlight configuration	configuration of headlights		0-255	15		
56 Operating range of	0 – 100 % load control Defines up to which speed in % load control will be active. A value of 32 indicates that load control will be effective up to half speed.	1-64	64		Description	Value				
57 Sound mode 1	Multiplied by 0,64 is the time in seconds between two chuff sounds at speed step 1. Value 0 indicates that period between exhaust chuffs is controlled by a wheel sensor	0-127 Steam:15; Diesel: 0	32		continuous (dimmer)	Vol +0 (Vol)				
58 Sound mode 2	Value defines the gradual decrease of intervals of exhaust chuffs with increasingspeed.A higher value indicates a more rapid decrease, a lower value a slower decrease. If exhaust chuffs are triggered by a wheel sensor (if CV 57 = 0), this value specifies the number of trigger pulses required for one exhaust chuff.	0-127 Steam: 15; Diesel/ Electric: 0			blinking (phase 1)	Vol + 16				
59 Lowest Speed Step	Divided by 32 this will yield the factor for eproducing the sound at the slowest speed step. Values < 32 are slower, values > 32 are faster than original speed.	0-64	114 Back light configuration		configuration of back lights, see also CV113	0-255			15	
60 Highest Speed Step	Divided by 32 this will yield the factor for reproducing the sound at the fastest speed step values < 32 are slower, values > 32are faster than original speed.	0-64	115 Aux 1 configuration		configuration of Aux 1, see also CV113	0-255			15	
61 Random sound min	Multiplied by 1 is the time in secs. for the shortest random sound interval. These values represent the interval between Random sounds.	0-64	116 Aux 2 configuration		configuration of Aux 2, see also CV113	0-255			15	
62 Random sound max	Multiplied by 1is the time in seconds for the longest interval between random sounds.These values represent the interval between random sounds. Playing of random sounds is deactivated when CV 61 and CV 62 = 0	0-64	117 Aux 3 configuration		configuration of Aux 3, see also CV113	0-255			15	
63 Sound volume	volume of running and additional sounds	0-64	118 Aux 4 configuration		configuration of Aux 4, see also CV113	0-255			15	
64 Brake sound threshold	Specifies when the decoder starts the braking noises. The higher the value, the sooner it will start. If CV 64= 0, the braking sound is only played once the engine has stopped.	0-64	119 Aux 5 configuration		configuration of Aux 5, see also CV113 (Loksound XL only)	0-255			15	
66 Forward trim	Value divided by 128 is the factor used to multiply the motor voltage when driving forward. Value 0 deactivates the trim.	0-255	0		120 Aux 6 configuration	configuration of Aux 6, see also CV113 (Loksound XL only)			0-255	15
					121 Volume Control 1	Subgroup volume for all sounds routed to Volume Control 1(horn / whistle)			0-64	64
					122 Volume Control 2	Subgroup volume for all sounds routed to Volume Control 2 (bell)			0-64	64
					123 Volume Control 3	Subgroup volume for all sounds routed to Volume Control 1 (auxiliary)			0-64	64
					124 Special Options	Activates special options			0-128	0
				Bit		Description	Value			
				0		Store direction	1			
				1		Store function state	2			
				2		Store current speed setting	4			
				3		Start again with acceleration ramp	8			
				4	Deactivate load dependent sound	16				
				5	Disable motor EMK meassure	32				
				125 Start Voltage DC	The value multiplied by 0.2 equals the voltage value	0-127	20			
				126 Maximum speed DC	The value multiplied by 0,2 equals the voltage value	0-127	60			
				127 Start voltage AC	The value multiplied by 0.2 equals the voltage value	0-127	30			
				128 Maximum speed AC	The value multiplied by 0.2 equals the voltage value	0-127	80			

CV Overview Chart

CV Name	Description	Range	Def.	CV Name	Description	Range	Def.																
129 Assignment of function „stop“ forward A	Assignment of function outputs activated in status „stop – forward“	0-255	0	144 Assignment of function Light Backward A	Assignment of function outputs, activated in light backward; see CV132	0-255	0																
	Bit Description value				145 Assignment of function Light Backward B			Assignment of function outputs, activated in light backward; see CV133															
	0 headlights							1	146 Assignment of function Light Backward C	Assignment of function outputs, activated in light backward; Soundslot 1- 16													
	1 back lights							2		147 Assignment of function F1 Forward A	Assignment of function outputs, activated in F1 forward; see CV129												
	2 function output AUX 1							4			148 Assignment of function F1 Forward B	Assignment of function outputs, activated in F1 forward; see CV130											
	3 function output AUX 2							8				149 Assignment of function F1 Forward C	Assignment of function outputs, activated in F1 forward; Soundslot 1 - 16										
	4 function output AUX 3							16					150 Assignment of function F1 Backward A	Assignment of function outputs, activated in F1 backward; see CV132									
	5 function output AUX 4							32						151 Assignment of function F1 Backward B	Assignment of function outputs, activated in F1 backward; see CV133								
6 function output AUX 5 (Loksound XL), Diesel Notching Up (LSV3.5 und micro)	64	152 Assignment of function F1 Backward C	Assignment of function outputs, activated in F1 backward; Soundslot 1- 16																				
7 function output AUX 6 (Loksound XL), Diesel Notching down (LSV3.5 und micro)	128		153 Assignment of function F2 Forward A	Assignment of function outputs, activated in F2 forward; see CV129																			
130 Assignment of function „stop“ forward B	Assignment of function outputs activated in status „stop – forward“			0-255	0	154 Assignment of function F2 Forward B	Assignment of function outputs, activated in F2 forward; see CV130	0-255	0														
	Bit Description value						155 Assignment of function F2 Forward C			Assignment of function outputs, activated in F2 forward; Soundslot 1 - 16													
	0 acceleration on / off									1	156 Assignment of function F2 Backward A	Assignment of function outputs, activated in F2 backward; see CV132											
	1 shunting mode on / off									2		157 Assignment of function F2 Backward B	Assignment of function outputs, activated in F2 backward; see CV133										
	2 sound on / off									4			158 Assignment of function F2 Backward C		Assignment of function outputs, activated in F2 backward; Soundslot 1- 16								
	3 shift mode									8					159 Assignment of function F3 Forward A	Assignment of function outputs, activated in F3 forward; see CV129							
	4 Fan sound									16						160 Assignment of function F3 Forward B	Assignment of function outputs, activated in F3 forward; see CV130						
	5 Doppler on/off									32							161 Assignment of function F3 Forward C	Assignment of function outputs, activated in F3 forward; Soundslot 1 - 16					
6 Mute / Volume Control	64			162 Assignment of function F3 Backward A	Assignment of function outputs, activated in F3 backward; see CV132																		
7 Dynamic Brake	128				163 Assignment of function F3 Backward B					Assignment of function outputs, activated in F3 backward; see CV133													
131 Assignment of function „stop“ forward C	Assignment of function outputs activated in status „stop – forward“									0-16								0	164 Assignment of function F3 Backward C	Assignment of function outputs, activated in F3 backward; Soundslot 1- 16	0-16	0	
	Bit Description Value																			165 Assignment of function F4 Forward A			Assignment of function outputs, activated in F4 forward; see CV129
	0-3 Soundslot 1 - 16																						0
132 Assignment of function „stop“ backward A	Assignment of function outputs activated in status „stop – backward“ refer to CV 129									0-255								0		167 Assignment of function F4 Forward C			Assignment of function outputs, activated in F4 forward; Soundslot 1 - 16
	133 Assignment of function „stop“ backward B	Assignment of function outputs activated in status „stop – backward“ refer to CV 130	0-255	0	168 Assignment of function F4 Backward A	Assignment of function outputs, activated in F4 backward; see CV132																	
134 Assignment of function „stop“ backward C	Assignment of function outputs activated in status „stop – forward“	0-16				0	169 Assignment of function F4 Backward B	Assignment of function outputs, activated in F4 backward; see CV133	0-255	0													
	Bit Description Value		170 Assignment of function F4 Backward C	Assignment of function outputs, activated in F4 backward; Soundslot 1- 16																			
0-3 Soundslot 1 - 16	0																						
135 Assignment of function Driving Forward A	Assignment of function outputs, activated in when driving forward; see CV129	0-255	0																				
136 Assignment of function Driving Forward B	Assignment of function outputs, activated in when driving forward; see CV130	0-255	0																				
137 Assignment of function Driving Forward C	Assignment of function outputs, activated in when driving forward; Soundslot 1 - 16	0-16	0																				
138 Assignment of function Driving Backward A	Assignment of function outputs, activated in when driving backward; see CV132	0-255	0																				
139 Assignment of function Driving Backward B	Assignment of function outputs, activated in when driving backward; see CV133	0-255	0																				
140 Assignment of function Driving Backward C	Assignment of function outputs, activated in when driving backward; Soundslot 1- 16	0-16	0																				
141 Assignment of function Light Forward A	Assignment of function outputs, activated in light forward; see CV129	0-255	0																				
142 Assignment of function Light Forward B	Assignment of function outputs, activated in light forward; see CV130	0-255	0																				
143 Assignment of function Light Forward C	Assignment of function outputs, activated in light forward; Soundslot 1 - 16	0-16	0																				

CV Overview Chart

CV Name	Description	Range	Def
227 Assignment of function F14 Forward C	Assignment of function outputs, activated in F14 forward; Soundslot 1 - 16	0-16	0
228 Assignment of function F14 Backward A	Assignment of function outputs, activated in F14 backward; see CV132	0-255	0
229 Assignment of function F14 Backward B	Assignment of function outputs, activated in F14 backward; see CV133	0-255	0
230 Assignment of function F14 Backward C	Assignment of function outputs, activated in F14 backward; Soundslot 1- 16	0-16	0
231 Assignment of function F15 Forward A	Assignment of function outputs, activated in F15 forward; see CV129	0-255	0
232 Assignment of function F15 Forward B	Assignment of function outputs, activated in F15 forward; see CV130	0-255	0
233 Assignment of function F15 Forward C	Assignment of function outputs, activated in F15 forward; Soundslot 1 - 16	0-16	0
234 Assignment of function F15 Backward A	Assignment of function outputs, activated in F15 backward; see CV132	0-255	0
235 Assignment of function F15 Backward B	Assignment of function outputs, activated in F15 backward; see CV133	0-255	0
236 Assignment of function F15 Backward C	Assignment of function outputs, activated in F15 backward; Soundslot 1- 16	0-16	0
237 Assignment of function Sensor 1 Forward A	Assignment of function outputs, activated in Sensor 1 forward; see CV129	0-255	0
238 Assignment of function Sensor 1 Forward B	Assignment of function outputs, activated in Sensor 1 forward; see CV130	0-255	0
239 Assignment of function Sensor 1 Forward C	Assignment of function outputs, activated in Sensor 1 forward; Soundslot 1 - 16	0-16	0
240 Assignment of function Sensor 1 Backward A	Assignment of function outputs, activated in Sensor 1 backward; see CV132	0-255	0
241 Assignment of function Sensor 1 Backward B	Assignment of function outputs, activated in Sensor 1 backward; see CV133	0-255	0
242 Assignment of function Sensor 1 Backward C	Assignment of function outputs, activated in Sensor 1 backward; Soundslot 1- 16	0-16	0
243 Assignment of function Sensor 2 Forward A	Assignment of function outputs, activated in Sensor 2 forward; see CV129	0-255	0
244 Assignment of function Sensor 2 Forward B	Assignment of function outputs, activated in Sensor 2 forward; see CV130	0-255	0
245 Assignment of function Sensor 2 Forward C	Assignment of function outputs, activated in Sensor 2 forward; Soundslot 1 - 16	0-16	0
246 Assignment of function Sensor 2 Backward A	Assignment of function outputs, activated in Sensor 2 backward; see CV132	0-255	0
247 Assignment of function Sensor 2 Backward B	Assignment of function outputs, activated in Sensor 2 backward; see CV133	0-255	0
248 Assignment of function Sensor 2 Backward C	Assignment of function outputs, activated in Sensor 2 backward; Soundslot 1- 16	0-16	0
249 Minimum distance of the steam chuffs	The time interval in milliseconds that the steam chuffs can have to each other	0-255	0
250 Time for the steam shifts flow	Relative throughput time of one steam shifts	0-255	0
251 Earliest relative starting position for Steam Shift	Relative distance of the steam Shifts to the previous chuff position for Steam Shift	0-255	0
252 Latest relative starting position for Steam Shift	Relative distance of the steam shifts to the subsequent chuff	0-255	0



Licence Agreement

This license agreement („the Agreement“) is a legal agreement between you and ESU, LLC („ESU“) for the sound samples („Sound Samples“) and software licensed from this internet site („Content“) as well as other content owned by ESU and its third party licensors that also includes images, mixes and documentation. By installing or using the Content, you are agreeing to be bound by the terms of this Agreement. IF YOU DO NOT AGREE TO THE TERMS OF THIS AGREEMENT, YOU ARE GRANTED NO RIGHTS IN RESPECT OF THE CONTENT AND MUST PROMPTLY DELETE THE CONTENT YOU HAVE INSTALLED.

1. GRANT OF LICENSE

1.1 ESU grants you a non-transferable, limited, non-exclusive right to use the Content solely for your own personal purposes. You may load the Content into RAM, as well as installation on a hard disk or other storage device on a single computer, hardware product or mobile device owned by you or under your control. The installation process may result in a copy of the Content residing on your computer, in which case, you may retain one (1) copy of the Content on your computer, provided that you retain all copyright and other proprietary notices on the copy and the copy is kept in your possession with the original.

1.2 By using the Content, you shall not obtain any ownership, copyright, proprietary or other interest in or to the Content. The Content is licensed, not sold.

1.3 You are licensed to use, modify and combine the Sound Samples with sound samples provided by third parties, to create your own sound compositions which, subject to you complying with the terms of this Agreement, you are free to distribute as you wish provided that: (i) the Sound Samples have been mixed together to create an original work; (ii) individual Sound Samples are not used in isolation and (iii) the Sound Samples or derivatives are not used to create sound libraries for distribution to third parties.

2. PROHIBITED USES

Neither you, nor anyone at your direction, shall:
2.1 use the Content, or any part of it, for any public performance, live broadcast or time delayed live broadcast where the Content is used unattended for commercial purposes without ESU's prior written consent;
2.2 use the Content, or any part of it, in any competitive product;

2.3 sub-license, copy, reproduce, transmit, assign, rent, sell, lease, offer on a pay-per-play basis, distribute for money or any other consideration, or commercially exploit in any other manner or through any medium whatsoever or otherwise transfer in any way the Content or any part thereof;

2.4 manufacture and/or distribute for money or otherwise commercially exploit any product that incorporates any part of the Content. If you wish to use any part of the Content for manufacture, resale, sub-license or further distribution, you must contact ESU (and where relevant, its licensors) to enter into an appropriate agreement with ESU (and, where relevant, its licensors);

2.5 publish the results of any analysis or comparative evaluation of the Content or any part thereof without ESU's prior written consent;

2.6 reverse engineer, recompile or disassemble any part of the Content except to the extent and in the circumstances expressly permitted by ESU and its licensors in writing or by law;

3. INTELLECTUAL PROPERTY RIGHTS

You acknowledge that all intellectual property rights in the Content are and shall remain vested in ESU and its licensors. You undertake not to interfere with or diminish, whether by act or omission, the rights, title and interest in the Content of ESU and its licensors. You may be held responsible by ESU and/or any of its licensors for any infringement of any intellectual property rights in the Content. For the avoidance of doubt, provided that you comply with the terms of this Agreement, ESU shall not claim ownership of the intellectual property rights in any compositions created by your use of the Content.

4. TERM AND TERMINATION

This Agreement is effective from the first date you install the Content. The rights granted to you under this Agreement shall terminate if you fail to abide by its terms. Upon such termination you agree to destroy the Content including any Content stored on the hard disk of any computer under your control. You may terminate this Agreement at any time by destroying or erasing all your copies of the Content. Any termination of this Agreement (howsoever occasioned) shall not affect any accrued rights or liabilities of you or ESU nor shall it affect the coming into force or the continuance in force of the provisions of Clauses 2, 3, 5 and 6 and any provision hereof which is by implication intended to come into or continue in force on or after such termination.

5. NO WARRANTIES

TO THE MAXIMUM EXTENT PERMITTED BY APPLICABLE LAW, ESU AND ITS LICENSORS PROVIDE THE CONTENT „AS IS“ AND ESU EXCLUDES ON BEHALF OF ITSELF AND ITS LICENSORS, ALL CONDITIONS, TERMS, REPRESENTATIONS (OTHER THAN FRAUDULENT REPRESENTATIONS) AND WARRANTIES RELATING TO THE CONTENT, WHETHER IMPOSED BY STATUTE OR BY OPERATION OF LAW OR OTHERWISE, INCLUDING BUT NOT LIMITED TO, IMPLIED WARRANTIES OF SATISFACTORY QUALITY AND FITNESS FOR A PARTICULAR PURPOSE. NEITHER ESU NOR ITS LICENSORS WARRANT THAT THE OPERATION OF THE CONTENT WILL BE UNINTERRUPTED, ERROR FREE, VIRUS FREE OR MEET YOUR SPECIFIC REQUIREMENTS. YOU MAY HAVE OTHER RIGHTS THAT VARY FROM JURISDICTION TO JURISDICTION.

6. ESU's LIABILITY

Neither ESU nor its licensors shall have any liability to you for any loss or damage caused directly or indirectly in connection with the Content, any part thereof or this Agreement, except to the extent that such liability cannot be lawfully excluded. In any case, neither ESU nor its licensors shall be liable for any loss of business, data, profits, savings, or any other special, incidental, consequential, indirect or economic loss whatsoever even if such losses were contemplated at the date of this Agreement

7. GENERAL

7.1 You acknowledge that damages alone might be insufficient remedy for any breach of the terms of this Agreement and that the remedies of injunction, specific performance or other equitable relief would be suitable remedies in the event of any breach or threatened breach of this Agreement.

7.2 You may not assign or otherwise transfer all or any part of this Agreement or the rights granted to you hereunder.

7.3 ESU is not obliged to provide any maintenance, technical support or upgrades to you.

7.4 You agree to comply with all applicable import and export regulations and acknowledge that you have the responsibility for obtaining all necessary licenses to export, re-export, transfer or import the Content.

7.5 This Agreement constitutes the entire agreement between you and ESU with respect to the subject matter hereof and supersedes all prior agreements, arrangements and understandings between the parties and constitutes the entire agreement between the parties relating to such subject matter hereof. No addition to or modification of any provision of this Agreement shall be binding upon ESU and you unless made by a written instrument signed by a duly authorized representative of ESU and you.

7.6 No forbearance, delay or indulgence by either party in enforcing the provisions of this Agreement shall prejudice or restrict the rights of that party nor shall any waiver of its rights operate as a waiver of any subsequent breach and no right, power or remedy herein conferred upon or reserved for either party is exclusive of any other right, power or remedy available to that party and each such right, power or remedy shall be cumulative.

7.7 Notwithstanding that the whole or any part of any provision of this Agreement may prove to be illegal or unenforceable the other provisions of this Agreement and the remainder of the provision in question shall remain in full force and effect.

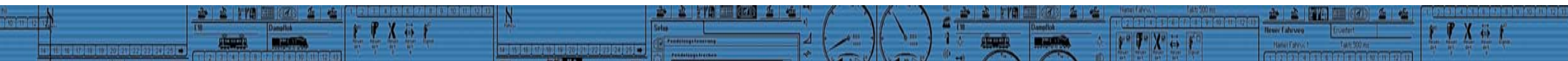

Warranty card Goods return note

1. Customer data

(Please write in block letters)

Name:
Street:
Postal Code / Town: | | | | | | | | | |
Country:
E-Mail:
Telephone:
Date:.....
Signature: ...X

2. Type of fault

- Network connection
 Data connector
 Input (PC)
 Output (track)
 LED display
 Body

3. Description of software bug (use extra page, if necessary)

.....
.....
.....
.....
.....

4. Receipt of purchase

Please enclose the receipt to the shipment!

5. Details of retailer

.....
.....
.....
.....
.....

Retailer's stamp or address



Warranty certificate

24 months warranty from date of purchase

Dear customer,
congratulations to your purchase of this ESU product. This high tech product has been manufactured according to the latest production processes and has passed stringent quality checks and tests. Therefore ESU electronic solutions ulm GmbH & Co KG offers you in addition to the national warranty rights as governed by law a special

manufacturers warranty of 24 months from date of purchase

Warranty conditions:

- This warranty is valid for all ESU products, purchased at an ESU dealer.
- Any repair or replacement under this warranty is subject to proof of purchase. The warranty certificate completed by your ESU dealer together with the receipt serves as the proof of purchase. We recommend to keep the receipt together with the certificate.
- Please fill in the goods return note on the left accurately and send it in as well.

Content of warranty / exemptions:

The warranty of ESU electronic solutions ulm GmbH & Co KG comprises the free of charge disposal or replacement of any faulty part due to faulty **design, manufacturing or material or transport damage**.

Any further claims are excluded.

This warranty expires:

1. in case of failure due to wear and tear
2. if ESU products have been modified with parts not approved by ESU
3. if parts have been altered, especially missing shrink sleeves, or wires soldered directly to the decoder
4. if the product is used for a different purpose than the one intended by the manufacturer
5. if recommendations issued by ESU electronic solutions ulm GmbH & Co KG are not adhered to.

For reasons of liability no examination or repairs can be carried out on parts built into locos or coaches.

The warranty period will not be extended due to repairs or replacement.

You may submit your claim by either returning the faulty product to your dealer or by shipping it directly to ESU electronic solutions ulm GmbH & Co KG together with the warranty certificate, the receipt and a detailed description of the fault.

ESU electronic solutions ulm GmbH & Co. KG
- Warranty department-
Industriestrasse 5
D-89081 Ulm

